

GMC PUBLICATIONS LTD



RIGHTS GUIDE

2024/2025



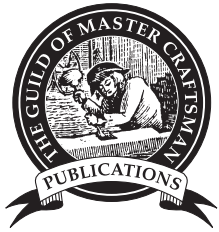

GMC PUBLICATIONS LTD

RIGHTS GUIDE

2024/2025

OUTDOOR CRAFT	3
COOKERY	7
NEEDLECRAFT	8
PAPERCRAFT	22
ART	24
JEWELLERY & MINIATURES	26
COLOURING & KIDS' CRAFT	27
WOODWORKING	28

PETER BENSON set up the Essex School of Woodcarving in 1996. He runs many workshops overseas as well as judging competitions around the world. He writes regularly for woodcarving journals and is an established author.

HB arlin · 210 × 148 mm · Full colour throughout

WHITTLING WILDLIFE

PETER BENSON

Seasoned woodcarver Peter Benson guides readers through the basics of whittling, featuring 15 aquatic animals to carve. The book explains what equipment is needed, giving essential advice on best practises and showing how to carve safely. The projects have clearly presented, easy-to-follow instructions that increase in difficulty. Projects include a dolphin, polar bear, kingfisher and more.

144 pages

Full colour throughout

ISBN: 9781784946944 · SKU: GM-51403 · £14.99

Publishing June 2025



WHITTLING WALKING STICKS

PETER BENSON

Intricately carved and infused with character, this charming collection of 10 whittled stick toppers is perfect for would-be whittlers and those with some whittling experience who wish to hone their skills. The main tools you'll need, plus the basic techniques and how to perform them safely are all covered in a clear and easy-to-follow way.

136 pages

12 templates · 238 photographs

ISBN: 9781784946753 · SKU: GM-51221 · £14.99

NEW



WHITTLING WOODLAND ANIMALS

PETER BENSON

Whittling Woodland Animals introduces the simple art of whittling with 15 wilderness creatures to create from scratch. Projects include: bear, beaver, owl and hawk.

144 pages

18 templates · 289 photographs

ISBN: 9781784946586 · SKU: GM-51116 · £14.99

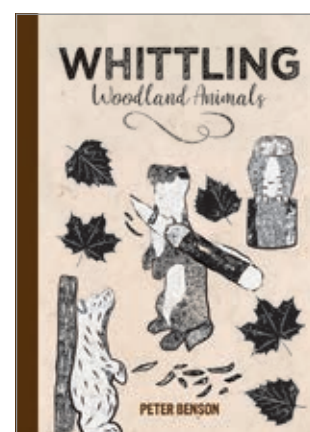

WOODLAND WHITTLING

PETER BENSON

This delightful book guides you through the basics of woodland whittling, explaining what equipment you need, how to hold the knife, and what timber to use. The projects are then all described in detail with clear step-by-step photographs. Projects include: letter opener, thumb stick, ring tree and egg cup.

144 pages

4 templates · 237 photographs

ISBN: 9781784945091 · SKU: GM-29442 · £12.99

WHITTLING HANDBOOK

Peter Benson

PB · 210 × 148 mm · 128 pages

5 templates · 300 photographs

ISBN: 9781784940751

SKU: GM-25478 · £7.99



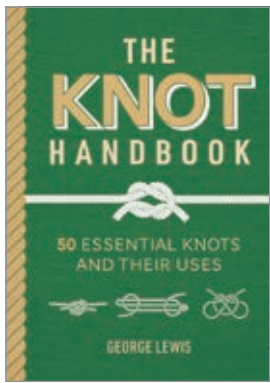

THE KNOT HANDBOOK
50 ESSENTIAL KNOTS AND THEIR USES
GEORGE LEWIS

A fresh redesign of the bestselling *The Knot Handbook* shows readers how to tie 50 knots, classified by their area of use with easy-to-follow instructions.

HB · 178 × 124 mm · 112 pages
417 illustrations · 11 photographs
ISBN: 9781784946746 · SKU: GM-51218 · £12.99

NEW

-  CLIMBING
-  CAMPING
-  ARBORIST
-  HOUSEHOLD
-  EQUESTRIAN
-  RESCUE
-  BOATING
-  FISHING



BEN LAW is woodsman, craftsman, eco-builder, teacher and writer. He runs courses on sustainable woodland management and permaculture and lives and works in his own woodland in West Sussex. www.benlaw.co.uk

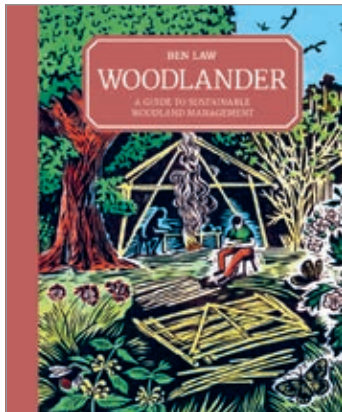

WOODLANDER
A GUIDE TO SUSTAINABLE
WOODLAND MANAGEMENT
BEN LAW

HB with jacket · 260 × 215 mm · 184 pages
116 illustrations · 186 photographs
ISBN: 9781784945572 · SKU: GM-30546 · £25.00

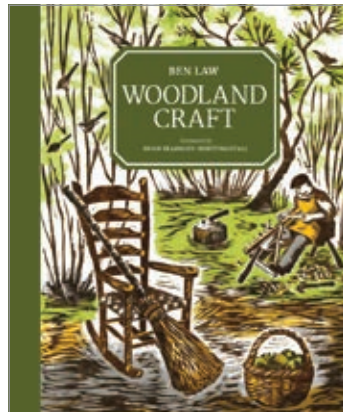

WOODLAND CRAFT
BEN LAW, FOREWORD BY
HUGH FEARNLEY-WHITTINGSTALL

HB with jacket · 260 × 215 mm · 216 pages
185 illustrations · 496 photographs
ISBN: 9781861089366 · SKU: GM-21569 · £25.00

PB Edition
PB with flaps · 240 × 198 mm · 216 pages
185 illustrations · 496 photographs
ISBN: 9781784943967 · SKU: GM-28073 · £16.99

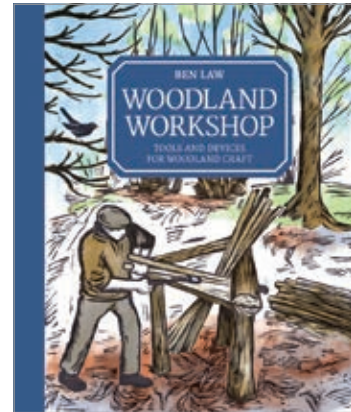

WOODLAND WORKSHOP
TOOLS AND DEVICES
FOR WOODLAND CRAFT
BEN LAW

HB with jacket · 260 × 215 mm · 208 pages
120 illustrations · 300 photographs
ISBN: 9781784943431 · SKU: GM-27111 · £25.00

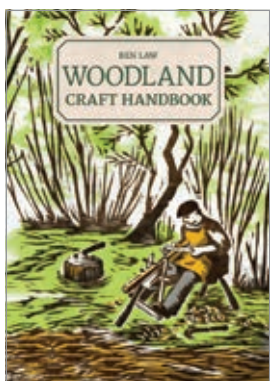

WOODLAND CRAFT HANDBOOK
Ben Law
HB · 210 × 148 mm · 168 pages
123 illustrations · 220 photographs
ISBN: 9781784946159
SKU: GM-50804 · £12.99

"The projects that follow are inspiring and accessible too, whether you want to whittle your own spoons or go as far as constructing a timber-frame caravan."

Hugh Fearnley-Whittingstall on **Woodland Craft**



GREEN WOOD CARVING

HOW TO MAKE BEAUTIFUL OBJECTS FROM UNSEASONED WOOD

HARALD LAMON

Green Wood Carving includes fascinating information about wood, how it grows, how to use it and what makes it unique. The main carving tools, their uses, and how to look after them are also explained. From coat hooks and candlesticks to spoons and mugs, detailed step-by-steps explain each of the nine projects in words, photographs and drawings.

HB · 253 × 195 mm · 216 pages

17 illustrations/diagrams · 495 photographs

ISBN: 9781784946906 · SKU: GM-51365 · £25.00

Publishing September 2024



WILLOW WEAVING

HOW TO MAKE WILLOW BASKETS USING TRADITIONAL TECHNIQUES

EDDIE GLEW

Willow Weaving is a collection of 10 contemporary hand-woven projects, inspired by traditional woven baskets. The book starts with a brief history of basketmaking, before moving on to the practical details of willow growing and preparation, choosing the right tools for the workshop and a guide to the techniques needed to make the projects. Projects include a Catalan tray, garden trug and picnic hamper.

HB · 253 × 195 mm · 160 pages

Full colour throughout

ISBN: 9781784946920 · SKU: GM-51387 · £25.00

Publishing June 2025



WOODLAND WISDOM

A MISCELLANY OF FOREST FACTS, FICTION & FOLKLORE

NICK PIERCE

This beautifully illustrated, eclectic book contains a mixture of fact and fiction about woodlands and forests, including information about flora and fauna, woodland crafts, tree identification, foraging advice, folklore, mythology and much more. Simple step-by-steps show readers how to, among other things, make a bird house and bug hotel, press flowers, make a poultice and treat nettle sting.

HB cloth · 210 × 148 mm · 128 pages

70 illustrations

ISBN: 9781784946999 · SKU: GM-51409 · £14.99

Publishing October 2024

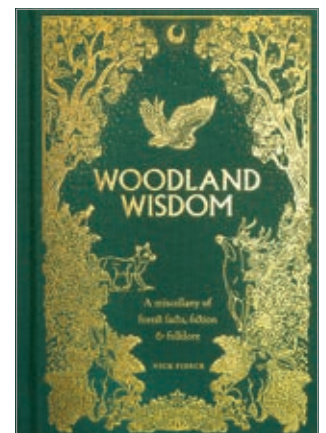
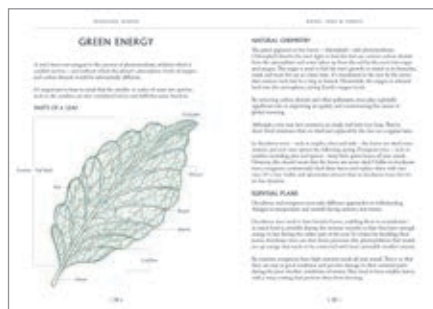
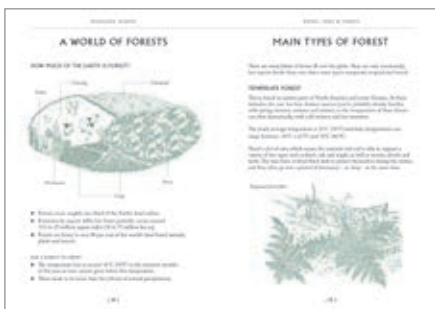

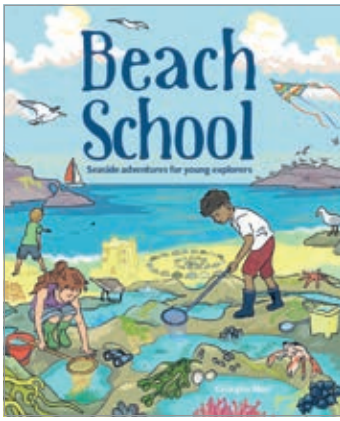

BEACH SCHOOL

SEASIDE ADVENTURES FOR YOUNG EXPLORERS
GEORGINA MAW

Featuring over 100 activities and crafts that allow kids to thrive in a beach setting, this book encourages children to explore their interests and develop essential life skills through nature-based play. From making campfires to identifying birds, *Beach School* highlights the importance of 'Blue Health' – the positive impact that water environments have on our wellbeing.

PB · 260 × 215 mm · 160 pages
Full colour throughout
ISBN: 9781784945886 · SKU: GM-50539 · £17.99
Publishing May 2025



RICHARD IRVINE is a Forest School Leader & Trainer with many years' experience in outdoor learning, forestry and greenwood carving. www.richardirvine.co.uk



FOREST CRAFT HANDBOOK

RICHARD IRVINE

With an emphasis on safety and adult supervision, this book presents a range of 20 simple and fun whittling projects for children to make such as a kazoo, mini furniture, duck call, whimsy diddle, rhythm sticks and elder wand. Dotted throughout are interesting nuggets of information about woodland folklore and inspirational photographs.

PB with flaps · 210 × 148 mm · 160 pages
56 illustrations · 310 photographs
ISBN: 9781784946951 · SKU: GM-51404 · £14.99
Publishing September 2024



FOREST CRAFT
Richard Irvine
PB with flaps
260 × 215 mm · 160 pages
70 illustrations
352 photographs
ISBN: 9781784945008
SKU: GM-29300
£17.99

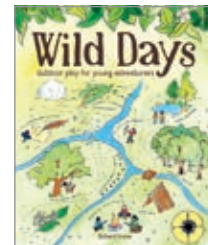

WILD DAYS
Richard Irvine
PB with flaps
260 × 215 mm · 160 pages
10 illustrations
400 photographs
ISBN: 9781784945831
SKU: GM-50494
£16.99



NAOMI WALMSLEY & DAN WALMSLEY run *Outback2Basics* from their woodland in Shropshire. Qualified leaders of Forest School and bushcraft, they provide unique experiences for children and teachers to connect to nature. www.thestoneage.co



FOREST SCHOOL HANDBOOK
Naomi Walmsley & Dan Westall
PB with flaps
210 × 148 mm · 168 pages
45 illustrations · 430 photographs
ISBN: 9781784946654
SKU: GM-51161 · £14.99



FOREST SCHOOL ADVENTURE
Naomi Walmsley & Dan Westall
PB with flaps
260 × 215 mm · 176 pages
20 illustrations · 250 photographs
ISBN: 9781784944032
SKU: GM-28384 · £17.99

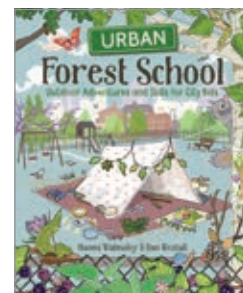

URBAN FOREST SCHOOL
Naomi Walmsley & Dan Westall
PB with flaps
260 × 215 mm · 160 pages
10 illustrations · 250 photographs
ISBN: 9781784945633
SKU: GM-30864 · £16.99



AN ENGLISH VINEYARD COOKBOOK

SEASONS, RECIPES, WINES & ART

THE GLADWIN FAMILY

A beautifully illustrated and practical guide from renowned chef Peter Gladwin that explores an array of delicious English cuisine and recipes from vineyards across the country.

HB • 248 × 195 mm • 256 pages

10 illustrations • 150 photographs

ISBN: 9781784946852 • SKU: GM-51318 • £25.00

Publishing September 2024

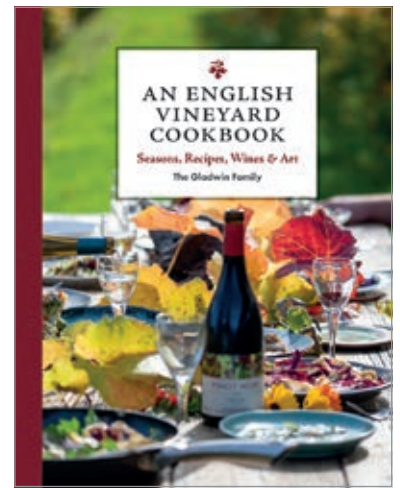

NICK WESTON is the founder of a foraging, butchery, cooking and bushcraft school in East Sussex. He is a survival expert and author of numerous publications including *The Treehouse Diaries*, written after living off the land for six months.

HUNTER GATHER COOK HANDBOOK

ADVENTURES IN WILD FOOD

NICK WESTON

Hunter Gather Cook Handbook combines accessible and inspirational instruction for foraging, game & fire cookery with over 40 recipes for the finest wild food. This new gift edition based on the best-selling guide *Hunter Gather Cook* aims to set the reader on a fulfilling, lifelong path of culinary adventures and food DIY, and inspire them to embrace the lifestyle that surrounds the 21st-century hunter-gatherer.

HB • 210 × 148 mm • 176 pages

85 photographs

ISBN: 9781784946333 • SKU: GM-50922 • £14.99



HUNTER GATHER COOK

Nick Weston

HB • 248 × 195 mm • 248 pages

410 photographs

ISBN: 9781784944179

SKU: GM-28497 • £25.00



WOOD-FIRED FEAST

OVER 100 RECIPES FOR THE WOOD-BURNING OVEN

JON FINCH

Wood-Fired Feast tells you everything you need to know about using a wood-fired oven and takes you on a journey from novice to master. It contains invaluable advice on buying a wood-fired oven, the tools and equipment needed, tips on wood selection and cooking temperatures, and easy step-by-step instructions for building and maintaining a fire. It includes over 100 recipes, some of which have been created by guest celebrity chefs.

HB • 248 × 195 mm • 224 pages

120 photographs

ISBN: 9781784946258 • SKU: GM-50868 • £25.00

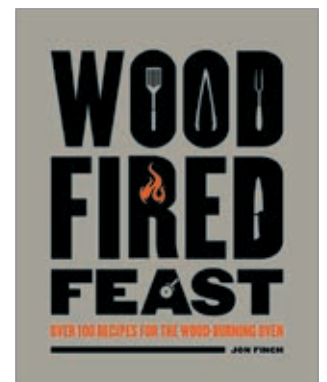

100 ESSENTIAL STITCHES

The ultimate go-to reference guides, ideal for beginners or those wanting to refresh their skills.

PB with flaps · 275 × 215 mm · Full colour throughout · £14.99

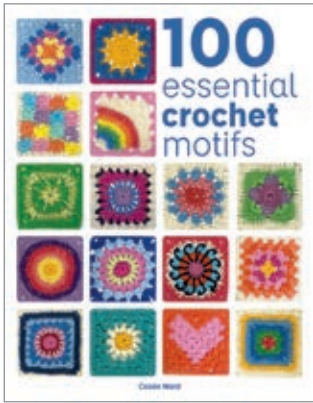

100 ESSENTIAL CROCHET MOTIFS

CASSIE WARD

From classic granny squares to contemporary designs, this book features 100 colourful and attractive motifs that can be used to personalise any crochet project. Including step-by-step instructions and detailed charts throughout, it is the perfect resource for novices, and an inspirational reference for advanced crocheters.

PB with flaps · 275 × 215 mm · 136 pages
Full colour throughout
ISBN: 9781784947040 · SKU: GM-51464 · £14.99

Publishing May 2025



100 ESSENTIAL CROCHET STITCHES

VAL PIERCE

136 pages
13 illustrations · 490 photographs
ISBN: 9781784945626
SKU: GM-30862 · £12.99



100 ESSENTIAL KNITTING STITCHES

SUSIE JOHNS

120 pages
23 illustrations · 218 photographs
ISBN: 9781784946661
SKU: GM-51162

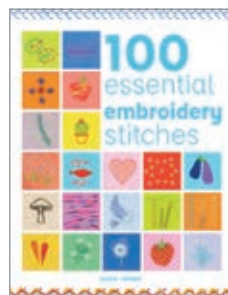

100 ESSENTIAL EMBROIDERY STITCHES

SUSIE JOHNS

136 pages
757 photographs
ISBN: 9781784946500
SKU: GM-51048

10,000 HATS

Interactive, fun and clever flip-page instruction books for designing and building unique hats. Combine different brims, bodies and crowns, equating to 10,626 ways to create your own patterns and styles.

HB concealed spiralbound · 260 × 215 mm · 80 pages · Full colour throughout · £17.99



10,000 KNITTED HATS

DISCOVER YOUR OWN UNIQUE DESIGN COMBINATIONS
JO ALLPORT

15 charts · 105 photographs
ISBN: 9781784946319
SKU: GM-50920



10,000 CROCHETED HATS

DISCOVER YOUR OWN UNIQUE DESIGN COMBINATIONS
EMMA VARNAM

1 chart · 68 illustrations
52 photographs
ISBN: 9781784946692
SKU: GM-51206

NEW



JACKIE DONHOU Jacki is a self-taught crocheter, she designs amigurumi and plush patterns. Her Instagram account is @dearjackistitchery.

CROCHETED MYTHICAL CREATURES

15 MAKES FROM LEGENDS, FOLKLORE AND FAIRYTALES

JACKI DONHOU

From ferocious dragons to mischievous sprites, each project comes with detailed and easy-to-follow instructions, perfect for beginner and more intermediate crocheters alike!

PB with flaps · 235 × 210 mm · 192 pages
100 photographs
ISBN: 9781784946876 · SKU: GM-51328 · £16.99

Publishing October 2024



YARN CAKE AMIGURUMI

15 CUTE CREATURES TO CROCHET

JACKI DONHOU

Yarn Cake Amigurumi is a collection of 15 adorable amigurumi animals and creatures to crochet using multicoloured yarn cakes. These creations will stand out among the sea of solid coloured amigurumi designs, with their bold, transitional striping and flair.

PB with flaps · 235 × 210 mm · 128 pages
100 photographs
ISBN: 9781784946678 · SKU: GM-51185 · £14.99

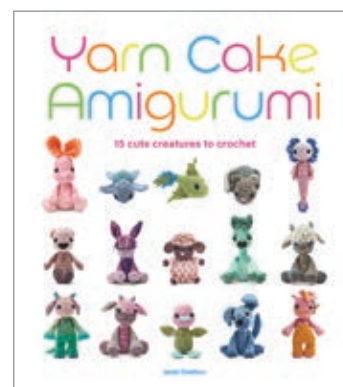

CROCHET CHRISTMAS

25 FESTIVE DECORATIONS TO MAKE

JACKI DONHOU, JOSEPHINE LAURIN, ANGEL KOYCHEV

Featuring 25 step-by-step projects to add handmade festive charm to decorations, gifts, ornaments and celebrations at Christmas. Projects include elves, snowmen, reindeer and angels.

PB · 275 × 215 mm · 144 pages
55 diagrams · 145 photographs
ISBN: 9781784946975 · SKU: GM-51406 · £16.99

Publishing September 2024



CROCHET AT WORK

20 CAREER DOLLS TO MAKE AND CUSTOMIZE

KATE MCCULLY

Crochet at Work contains 20 fun, customisable dolls to crochet – you can choose the body shape, skin and hair colour, hair style, and outfit. Each doll has been dressed in clothing that reflects an aspirational career, such as a chef, doctor, vet, explorer, astronaut, soldier, teacher or firefighter.

With comprehensive tools, materials and techniques sections, illustrated with helpful photographs and illustrations, beginners will be able to enjoy the projects as much as experienced crocheters.

PB with flaps · 254 × 203 mm · 136 pages
30 illustrations · 200 photographs
ISBN: 9781784946142 · SKU: GM-50782 · £14.99

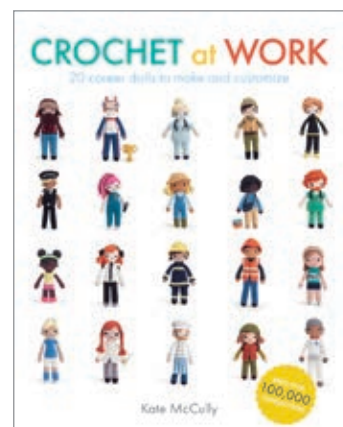

EMMA VARNAM is a bestselling author, designer (collaborating with Debbie Bliss) and award-winning knitting and crochet blogger. www.emmavarnam.co.uk



VINTAGE GRANNY SQUARES

20 CROCHET PROJECTS WITH A RETRO VIBE

EMMA VARNAM

From gorgeous blankets to colourful cushions, to stylish scarves, shrugs and mittens, this book is packed with inspiring projects that are guaranteed to get you reaching for your crochet hook. Patterns are based around the classic granny square, but with a modern twist. They won't take long to make and are quick and easy to complete once you know the basics of crochet.

PB with flaps · 235 × 210 mm · 144 pages
50 illustrations · 90 photographs
ISBN: 9781784946791
SKU: GM-51291 · £16.99

Publishing September 2024

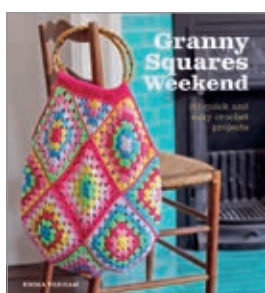

GRANNY SQUARES WEEKEND

Emma Varnam

PB with flaps
235 × 210 mm · 144 pages
30 illustrations · 150 photographs
ISBN: 9781784943844
SKU: GM-27950 · £14.99



GRANNY SQUARES HOME

Emma Varnam

PB with flaps
235 × 210 mm · 144 pages
40 illustrations · 150 photographs
ISBN: 9781784943639
SKU: GM-27651 · £14.99



CUTE CROCHETED FOOD

Emma Varnam

PB with flaps · 254 × 203 mm · 128 pages
150 illustrations · 100 photographs
ISBN: 9781784946609 · SKU: GM-51132 · £16.99



CUTE CROCHETED WOODLAND CREATURES

Emma Varnam

PB with flaps · 254 × 203 mm · 128 pages
30 illustrations · 200 photographs
ISBN: 9781784946036
SKU: GM-50684 · £12.99

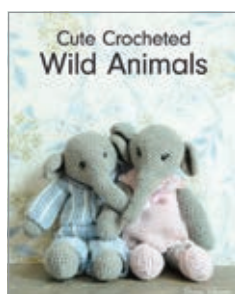

CUTE CROCHETED WILD ANIMALS

Emma Varnam

PB with flaps · 254 × 203 mm · 128 pages
160 charts · 70 illustrations
200 photographs
ISBN: 9781784945480
SKU: GM-30350 · £12.99



CUTE CROCHETED ANIMALS

Emma Varnam

PB with flaps · 254 × 203 mm · 128 pages
62 illustrations · 177 photographs
ISBN: 9781784942014
SKU: GM-26301 · £12.99

EMMA VARNAM is a bestselling author, designer (collaborating with Debbie Bliss) and award-winning knitting and crochet blogger. www.emmavarnam.co.uk

PB with flaps · 254 × 203 mm · 144 pages · Full colour throughout · £16.99

CROCHETED FLOWERS

30 STYLISH AND REALISTIC BLOOMS TO CREATE

EMMA VARNAM

An irresistible array of realistic blooms to crochet, these pretty projects are fun to make and the perfect way to use up oddments of yarn. With 30 botanical beauties to choose from, ranging from cheery sunflowers to ruffled roses, cool cornflowers and a bristling thistle, there's sure to be a favourite for everyone.

40 illustrations · 150 photographs
ISBN: 9781784946807 · SKU: GM-51292

NEW

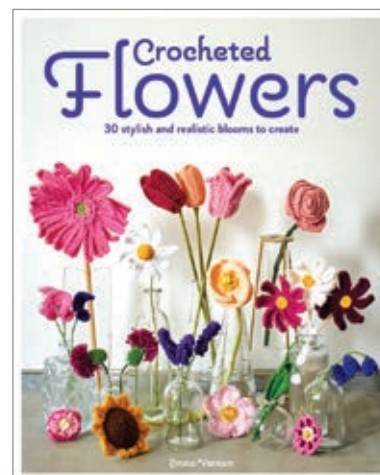

CROCHETED HOUSEPLANTS

BEAUTIFUL FLORA TO MAKE FOR YOUR HOME

EMMA VARNAM

Crocheted Houseplants features 25 stylish projects to revive your home or office décor and create a lush indoor garden. Flip through the stylish gallery pages, pick your favourite plants and get started. Everything you'll need to know is included in the book, from tools and materials to explanations of the basic crochet stitches. You'll also find out how to pot up and display your fabulous, crocheted creations.

35 illustrations · 200 photographs
ISBN: 9781784946418 · SKU: GM-51000



CROCHETED SUCCULENTS

CACTI & OTHER SUCCULENT PLANTS TO MAKE

EMMA VARNAM

If you love houseplants but have an unerring ability to kill everything off, fear not, because these cute creations don't require green fingers! There are 25 splendid succulents to make in a variety of shapes and sizes for a touch of indoor greenery that will never need watering, repotting or special plant food. Each project is beautifully photographed and includes clear patterns and guidance. There is also a techniques section that gives clear instructions on all the skills you'll need to make the projects.

35 illustrations · 180 photographs
ISBN: 9781784945046 · SKU: GM-29397

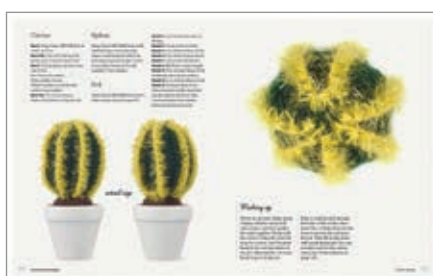



LITTLE CROCHET TREASURES

VANESSA MOONCIE

Vanessa Mooncie takes the reader on a making journey, explaining the techniques needed to produce a wide range of vibrant and exhilarating pieces; from intricate bumble bee brooch pins and vintage-inspired tattoo emblem brooches to delicate flower posy corsages and charming heart-shaped rings. The book is divided into four handy chapters covering brooches; necklaces; hairbands, rings and charms; tiepins, cufflinks and keyrings. Projects range in difficulty, with some being suitable for beginner crocheters, and others for those with more experience of the craft. With detailed patterns and useful hand-drawn charts, there's also an extensive techniques section explaining everything needed to complete the projects. Projects include: pretty posy brooch, daffodil headband, mod target cufflinks, loveheart tattoo necklace, charm bracelet and oak leaf and acorn pendant.

PB · 235 × 210 mm · 160 pages
18 illustrations · 118 photographs
ISBN: 9781784946968 · SKU: GM-51405 · £16.99

Publishing October 2024



VANESSA MOONCIE is a contemporary craftsperson, artist and author. She has written several books and written projects for various craft magazines and yarn companies. www.vanessamooncie.com



CROCHETED ANIMAL RUGS

Vanessa Mooncie
PB with flaps · 254 × 203 mm
184 pages · 200 illustrations
150 photographs
ISBN: 9781784945855
SKU: GM-50536 · £14.99



ANIMAL HEADS

Vanessa Mooncie
PB with flaps · 254 × 203 mm
192 pages · 187 charts
46 illustrations · 78 photographs
ISBN: 9781784940645
SKU: GM-25359 · £14.99



CROCHETED ANIMAL HATS

Vanessa Mooncie
PB with flaps · 235 × 210 mm
160 pages · 102 charts
69 illustrations · 100 photographs
ISBN: 9781861089748
SKU: GM-23170 · £14.99



ANIMAL HATS

Vanessa Mooncie
PB with flaps · 235 × 210 mm
128 pages · 4 charts
72 illustrations · 116 photographs
ISBN: 9781861088246
SKU: GM-19533 · £14.99



SIMPLE CROCHETED HATS

Vanessa Mooncie
PB with flaps · 254 × 200 mm
144 pages · 85 charts
63 illustrations · 72 photographs
ISBN: 9781784945404
SKU: GM-29976 · £14.99

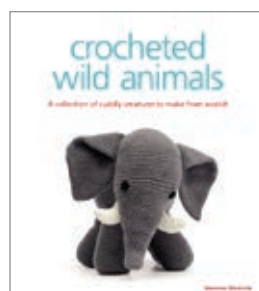

CROCHETED WILD ANIMALS

Vanessa Mooncie
PB with flaps · 235 × 210 mm
160 pages · 154 charts
41 illustrations · 175 photographs
ISBN: 9781861089267
SKU: GM-21510 · £14.99



CROCHETED SEA CREATURES

Vanessa Mooncie
PB with flaps · 235 × 210 mm
160 pages · 80 charts
30 illustrations · 175 photographs
ISBN: 9781861087577
SKU: GM-24231 · £14.99

VANESSA MOONCIE is a contemporary craftsperson, artist and author. She has written several books and written projects for various craft magazines and yarn companies. www.vanessamooncie.com

CROCHETED DINOSAURS

VANESSA MOONCIE

Travel back in time to the Jurassic period, with this enchanting collection of 10 crocheted dinosaurs. Each project contains detailed, easy-to-follow patterns, photographs and hand-drawn charts to help bring these prehistoric creatures to life. Varying in complexity, projects include a Pterodactyl, Triceratops, and Tyrannosaurus Rex.

PB with flaps · 254 × 203 mm · 160 pages

Full colour throughout

ISBN: 9781784947002 · SKU: GM-51426 · £16.99

Publishing July 2025



CROCHETED CATS

10 FELINE FRIENDS TO CROCHET

VANESSA MOONCIE

10 crochet patterns for 10 popular breeds including Siamese, tabby and tortoiseshell. Each project includes detailed patterns, stunning photographs and helpful hand-drawn charts. There is also an extensive techniques section explaining all the stitches and techniques you'll need to make your perfect feline friend.

PB with flaps · 254 × 203 mm · 176 pages

198 charts · 50 illustrations · 60 photographs

ISBN: 9781784946517 · SKU: GM-51052 · £16.99



CROCHETED DOGS

VANESSA MOONCIE

If you're looking for a beautiful and faithful companion then these gorgeous crocheted dogs have the right pedigree. Just as loyal and charming as the real thing, these 10 crocheted canines are sure to be everyone's best friend. Each project includes detailed patterns, stunning photographs and helpful hand-drawn charts.

PB with flaps · 254 × 203 mm · 160 pages

160 charts · 50 illustrations · 150 photographs

ISBN: 9781784945664 · SKU: GM-30865 · £14.99



CROCHETED BEES, BUGS & BUTTERFLIES

VANESSA MOONCIE

10 crochet projects including moths, beetles, butterflies and other insects. Once completed the projects can either be worn as an accessory, such as a brooch or hair decoration, or they can be mounted in a frame or bell jar for display.

PB with flaps · 254 × 203 mm · 144 pages

300 charts · 50 illustrations · 50 photographs

ISBN: 9781784946357 · SKU: GM-50924 · £14.99



CROCHETED BIRDS

A FLOCK OF FEATHERED FRIENDS TO MAKE

VANESSA MOONCIE

Featuring 10 gorgeous projects, all with stunning photographs and detailed charts, this book is a twitcher's delight. The extensive techniques section will tell you everything you need to know to make an entire crocheted aviary. There are also intricate charts included with the patterns to help you make your feathered friends come to life.

PB with flaps · 254 × 203 mm · 160 pages

160 charts · 50 illustrations · 150 photographs

ISBN: 9781784944582 · SKU: GM-28828 · £14.99





GRANNY SQUARES

Susan Pinner
PB with flaps
235 x 210 mm · 144 pages
37 illustrations · 140 photographs
ISBN: 9781861089700
SKU: GM-20838 · £14.99



MINI AMIGURUMI

Sara Scales
Booklet · 275 x 215 mm · 48 pages
Full colour throughout
ISBN: 9781784943950
SKU: GM-28042 · £5.99



MINI CROCHET CREATURES

Lauren Bergstrom
PB with flaps
254 x 203 mm · 160 pages
30 charts · 35 illustrations
200 photographs
ISBN: 9781784943899
SKU: GM-27998 · £14.99



NEEDLE FELTING

Emma Herian
PB with flaps
254 x 203 mm · 144 pages
300 photographs
ISBN: 9781784945152
SKU: GM-29788 · £14.99



QUICK & EASY MACRAMÉ

Tansy Wilson & Sian Hamilton
PB · 275 x 215 mm · 104 pages
41 illustrations · 397 photographs
ISBN: 9781784946722
SKU: GM-51213 · £12.99



MACRAMÉ

Tansy Wilson & Sian Hamilton
PB · 275 x 215 mm · 108 pages
15 illustrations · 350 photographs
ISBN: 9781784945800
SKU: GM-50444 · £9.99



MACRAMÉ

Tansy Wilson & Sian Hamilton
PB · 275 x 215 mm · 104 pages
Includes patterns · 15 illustrations
350 photographs
ISBN: 9781784946401
SKU: GM-50984 · £9.99

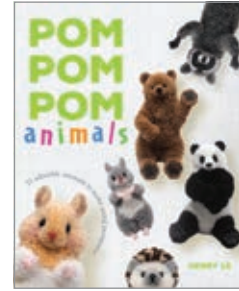

POM POM POM ANIMALS

Henry Le
PB with flaps
254 x 203 mm · 184 pages
100 charts · 1,500 photographs
ISBN: 9781784946647
SKU: GM-51160 · £16.99



POM POM POM

Henry Le
PB with flaps
254 x 203 mm · 176 pages
11 templates · 61 illustrations
587 photographs
ISBN: 9781784945169
SKU: GM-29828 · £14.99



POMPOM CRAFTS

Alison Howard
Booklet · 275 x 215 mm · 48 pages
1 template · 10 illustrations
73 photographs
ISBN: 9781784942595
SKU: GM-26570 · £5.99



TATTING JEWELLERY

Lyn Morton
PB with flaps · 235 x 210 mm
112 pages
52 diagrams · 150 photographs
ISBN: 9781861086761
SKU: GM-18230 · £12.99



TATTING PATTERNS

Lyn Morton
PB · 248 x 186 mm · 112 pages
70 charts · 78 b/w illustrations
86 photographs
ISBN: 9781861082619
SKU: GM-TATTING-1 · £9.99

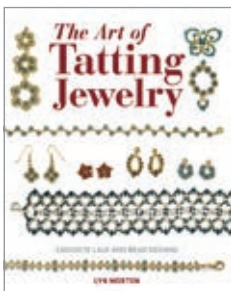

THE ART OF TATTING JEWELLERY

Lyn Morton
PB with flaps
254 x 203 mm · 112 pages
140 illustrations · 158 photographs
ISBN: 9781784942496
SKU: GM-26508 · £14.99

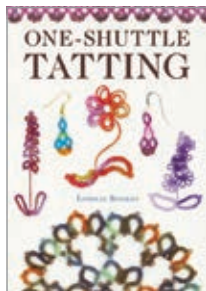

ONE-SHUTTLE TATTING

Lindsay Rogers
HB concealed spiralbound
210 x 148 mm · 80 pages
54 illustrations · 85 photographs
ISBN: 9781784944858
SKU: GM-29236 · £9.99



TATTING COLLAGE

Lindsay Rogers
HB concealed spiralbound
210 x 148 mm · 96 pages
120 b/w illustrations
70 b/w photographs
ISBN: 9781861089052
SKU: GM-20221 · £7.99



MASTERING TATTING

Lindsay Rogers
HB concealed spiralbound
238 x 168 mm · 112 pages
83 charts · 29 illustrations
102 photographs
ISBN: 9781861089502
SKU: GM-20763 · £12.99

KNITTED FLOWERS

30 SIMPLE FLORAL PATTERNS TO CREATE

SIAN BROWN

Show someone you care by giving them a bunch of flowers, but instead of the kind that will be past their best in a few days' time, why not knit them instead? With 30 beautiful blooms to choose from, including Poppy, Violet, Gerbera, Clematis and Rose, there's sure to be a favourite for everyone. There are plenty of other ways you can enjoy these adaptable makes, too: create a flower garland, or use them to embellish cushion covers, brooch backs, hair slides or key rings. These charming projects will bring a smile to all who receive them, and will give you hours of pleasure when knitting them. With detailed colour photographs of each flower and clear instructions, it's never been easier to grab your knitting needles and turn your stash of yarn remnants into floral works of art.

PB with flaps · 235 × 210 mm · 144 pages

100 photographs

ISBN: 9781784946777 · SKU: GM-51268 · £14.99

NEW



KNITTED CHRISTMAS STOCKINGS

25 FESTIVE DESIGNS TO MAKE FOR FAMILY AND FRIENDS

EMILEE REYNOLDS

Knitted Christmas Stockings is a joyful collection of 25 festive stocking designs for the whole family, including minimal modern designs, jolly elves, classic nativity scenes and traditional festive themes. Each design can be personalised with the name of the recipient or left blank. The essential know-how to get started is found at the back of the book: from which materials to buy to basic stitches to learn.

PB with flaps · 275 × 215 mm · 144 pages

32 charts · 50 photographs

ISBN: 9781784946685 · SKU: GM-51189 · £14.99



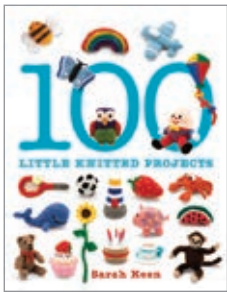

100 LITTLE KNITTED PROJECTS

Sarah Keen
PB with flaps · 275 × 215 mm
168 pages
22 illustrations · 283 photographs
ISBN: 9781861087997
SKU: GM-24762 · £14.99

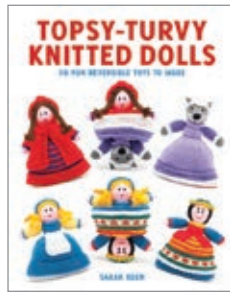

TOPSY-TURVY KNITTED DOLLS

Sarah Keen
PB with flaps · 254 × 203 mm
144 pages
26 diagrams/techniques
200 photographs
ISBN: 9781784942175
SKU: GM-26357 · £14.99



50 KNITTED DOLLS

Sarah Keen
PB with flaps · 275 × 215 mm
224 pages
26 illustrations · 282 photographs
ISBN: 9781784943462
SKU: GM-27516 · £14.99

SARAH KEEN is a freelance pattern and knitted toy designer and bestselling author.

PB with flaps · 235 × 210 mm · Full colour throughout · £14.99

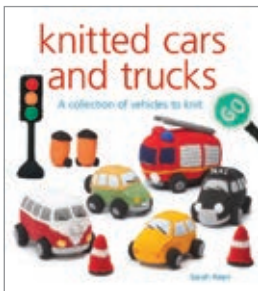

KNITTED CARS AND TRUCKS

Sarah Keen
152 pages
25 illustrations · 200 photographs
ISBN: 9781784945381
SKU: GM-29974

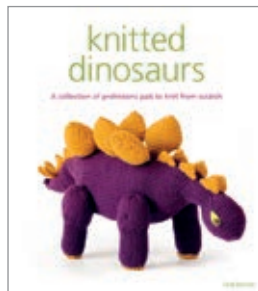

KNITTED DINOSAURS

Tina Barrett
128 pages
16 illustrations · 187 photographs
ISBN: 9781861088178
SKU: GM-19095



KNITTED FAIRY TALES

Sarah Keen
176 pages
14 illustrations · 197 photographs
ISBN: 9781861089694
SKU: GM-23136



KNITTED FARM ANIMALS

Sarah Keen
128 pages
21 illustrations · 183 photographs
ISBN: 9781861088468
SKU: GM-18690

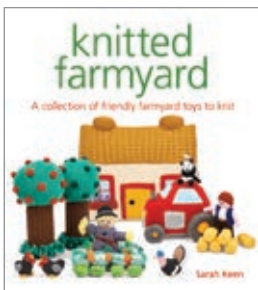

KNITTED FARMYARD

Sarah Keen
144 pages
27 illustrations · 164 photographs
ISBN: 9781784945183
SKU: GM-29826

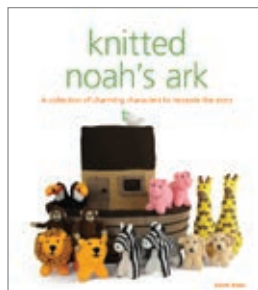

KNITTED NOAH'S ARK

Sarah Keen
128 pages
22 illustrations · 149 photographs
ISBN: 9781861089151
SKU: GM-20360

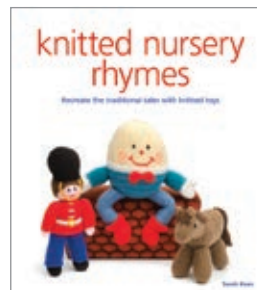

KNITTED NURSERY RHYMES

Sarah Keen
144 pages
14 illustrations · 137 photographs
ISBN: 9781861089410
SKU: GM-22029



KNITTED PETS

Susie Johns
128 pages
25 illustrations · 156 photographs
ISBN: 9781861088512
SKU: GM-19100



KNITTED SAFARI

Sarah Keen
192 pages
30 illustrations · 200 photographs
ISBN: 9781784944018
SKU: GM-28382



KNITTED SPACE

Sarah Keen
120 pages
30 illustrations · 150 photographs
ISBN: 9781784946050
SKU: GM-50699



KNITTED WILD ANIMALS

Sarah Keen
128 pages
19 illustrations · 165 photographs
ISBN: 9781861086709
SKU: GM-17972



KNITTED WOODLAND CREATURES

Susie Johns
144 pages
21 illustrations · 139 photographs
ISBN: 9781861089175
SKU: GM-22127

SARAH KEEN is a freelance pattern and knitted toy designer and bestselling author.

KNITTED FOREST FRIENDS

20 ADORABLE ANIMALS TO MAKE

SARAH KEEN

Knitted Forest Friends is a collection of 20 cute forest animals to knit, complete with clothes and accessories. All the animals have easy-to-follow patterns that are suitable for all abilities. The book also features a detailed technique section with abbreviations and knitting conversions. The projects range from a busy beaver, a bristling wild boar and a sleepy koala to a charismatic giant panda and a clever orang-utan.

PB with flaps · 235 × 210 mm · 160 pages
Full colour throughout
ISBN: 9781784946937 · SKU: GM-51402 · £16.99
Publishing April 2025



KNITTED FARM FRIENDS

20 ADORABLE ANIMALS TO MAKE

SARAH KEEN

Perfect as a special gift for a child, animal lover or simply to add to your own personal collection, these farm animals are bursting with character. The projects range from a sweet little buzzing bee, busy clucking hen and a vibrantly coloured pheasant to a proud goose and plump turkey. There's plenty to choose from. All the animals have easy-to-follow patterns, and this book also features detailed techniques, abbreviations and knitting conversions – allowing you to create with confidence.

PB with flaps · 235 × 210 mm · 160 pages
22 illustrations · 204 photographs
ISBN: 9781784946715 · SKU: GM-51210 · £16.99
NEW



KNITTED MENAGERIE

30 ADORABLE CREATURES TO KNIT

SARAH KEEN

Knitted Menagerie provides 30 easy-to-follow knitting patterns for an eclectic array of international animals. Complete beginners or knitters needing a refresher course can be reassured by the comprehensive illustrated techniques section provided. Packed with fun and enticing photography that shows each of the projects from different angles, this book is sure to delight the knitter and the lucky receiver of these gorgeous, knitted creatures.

PB with flaps · 235 × 210 mm · 160 pages
30 illustrations · 150 photographs
ISBN: 9781784946166 · SKU: GM-50810 · £16.99



CHRISTINE BOGGIS is the editor of *Knitting Magazine* also published by GMC Publications.



SIMPLY KNITTED SOCKS

30 BEAUTIFUL PATTERNS TO CREATE

CHRISTINE BOGGIS

Simply Knitted Socks is the perfect guide for anyone – seasoned knitter or complete beginner – looking to delve into the world of knitted socks to either create something for themselves, or to make bespoke and cosy gifts for men, women, and children.

PB with flaps · 254 × 203 mm · 152 pages
8 illustrations · 8 charts · 306 photographs
ISBN: 9781784946708 · SKU: GM-51208 · £14.99



KNITTED SHAWLS

25 RELAXING WRAPS, COWLS AND SHAWLS

CHRISTINE BOGGIS

This is a workbook with your health in mind: not only does it include 25 relaxing knitting patterns, plus a range of techniques to expand your skills, it also includes articles that explore the health benefits of knitting, how it can contribute to mindfulness and wellbeing, and much more. Suitable for everyone from beginners to experts, the workbook format introduces all the techniques you need before each design.

PB with flaps · 254 × 203 mm · 152 pages
10 illustrations · 250 photographs
ISBN: 9781784945848 · SKU: GM-50526 · £16.99



NO-SEW KNITTING

21 STYLISH DESIGNS FOR SEAM-FREE KNITS

CHRISTINE BOGGIS

No-Sew Knitting contains 21 projects for clothing, accessories and homeware for both adults and children, which do not require any sewing up. Each project is difficulty rated, making it easy to select based on time and/or ability and there are a wide range of yarns and sizing options to choose from. Each technique is clearly explained with easy-to-follow illustrations. Alongside the patterns there are useful measurement diagrams and tips to help the reader. It is also packed with beautiful and helpful photographs.

PB with flaps · 254 × 203 mm · 152 pages
10 charts · 250 photographs
ISBN: 9781784946340 · SKU: GM-50923 · £17.99



JOMO KNITS

21 PROJECTS TO CELEBRATE THE JOY OF MISSING OUT

CHRISTINE BOGGIS

An inspirational book of 21 gorgeous knitting projects which also includes insights into how to use knitting to unwind from the relentless demands of our over-stimulated and digitalised lives and rediscover how to connect with ourselves, and those around us, in a more meaningful way. Split into three main sections – Nest, Explore and Share – the projects are designed to be savoured, being in the moment and enjoying every stitch rather than worrying about achieving a perfect end result.

PB with flaps · 254 × 203 mm · 152 pages
6 charts · 7 illustrations · 264 photographs
ISBN: 9781784945053
SKU: GM-29435 · £14.99

PB with flaps · 275 × 215 mm · Full colour throughout · £12.99

FAT QUARTER: CELEBRATIONS

25 PROJECTS TO MAKE FROM SHORT LENGTHS OF FABRIC

SUSIE JOHNS

Featuring 25 simple stash-busting sewing projects for special occasions. Create a variety of practical and pretty items including garlands, wedding favours, party hats, decorative pumpkins, Christmas decorations and more.

160 pages

15 illustrations · 300 photographs

ISBN: 9781784946913 · SKU: GM-51371 · £14.99

Publishing October 2024

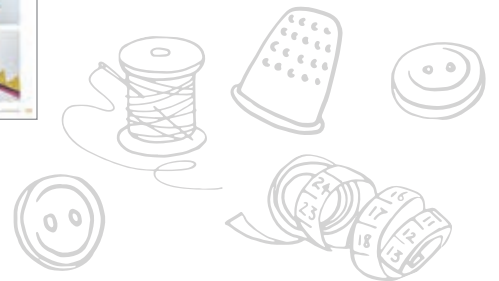

ACCESSORIES

Susie Johns

144 pages · 15 templates

300 photographs

ISBN: 9781784945657

SKU: GM-30863



BAGS & PURSES

Susie Johns

144 pages · 15 templates

352 photographs

ISBN: 9781784944193

SKU: GM-28495



CHRISTMAS

Jemima Schlee

152 pages · 22 templates

313 photographs

ISBN: 9781784943530

SKU: GM-27540



GIFTS

Jemima Schlee

152 pages · 17 templates

356 photographs

ISBN: 9781784943523

SKU: GM-27539



HOME

Amanda Russell
& Juliet Bawden

144 pages · 9 templates

242 photographs

ISBN: 9781784943851

SKU: GM-26932



ONE-PIECE PROJECTS

Tina Barrett

144 pages · 14 templates

10 illustrations

240 photographs

ISBN: 9781784944209

SKU: GM-28494



QUICK MAKES

Juliet Bawden
& Amanda Russell

144 pages · 8 templates

229 photographs

ISBN: 9781784943868

SKU: GM-26933



TOYS

Susie Johns

152 pages · 10 templates

240 photographs

ISBN: 9781784945138

SKU: GM-29586



VINTAGE

Susie Johns

152 pages · 15 templates

300 photographs

ISBN: 9781784944216

SKU: GM-28493

HOW TO Simple and clear step-by-step introductions to needlecraft. Each technique is clearly explained and accompanied by a stylish product to make.

PB · 275 × 215 mm · 92–120 pages · Full colour photographs · £7.99



HOW TO CROSS STITCH
Sian Hamilton
80 illustrations
ISBN: 9781784945688
SKU: GM-30867

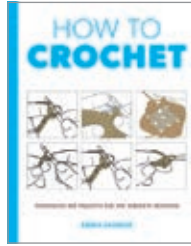

HOW TO CROCHET
Emma Varnam
169 illustrations
ISBN: 9781784943455
SKU: GM-27363

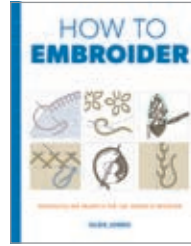

HOW TO EMBROIDER
Susie Johns
7 templates · 150 illustrations
ISBN: 9781784942991
SKU: GM-28381

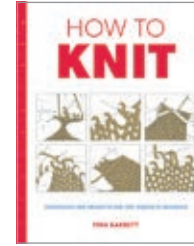

HOW TO KNIT
Tina Barrett
70 illustrations
ISBN: 9781784942939
SKU: GM-26743

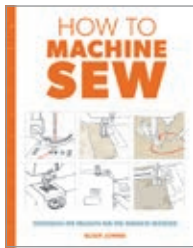

HOW TO MACHINE SEW
Susie Johns
180 illustrations
ISBN: 9781784942984
SKU: GM-28380

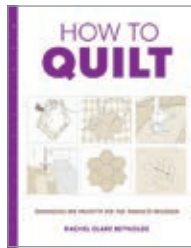

HOW TO QUILT
Rachel Clare Reynolds
199 illustrations
ISBN: 9781784942786
SKU: GM-26725

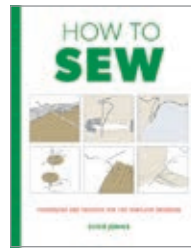

HOW TO SEW
Susie Johns
169 illustrations
ISBN: 9781784942946
SKU: GM-26744

WEEKEND MAKES

25 quick and easy projects to make in a weekend, learn a craft or try a new design idea.

PB with flaps · 275 × 215 mm · 144–152 pages · Full colour photographs · £14.99

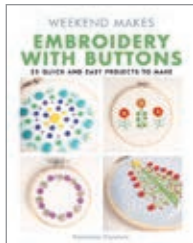

EMBROIDERY WITH BUTTONS
Rosemary Drysdale
29 diagrams
25 templates
ISBN: 9781784946456
SKU: GM-51014 · £16.99

NEW



CROCHETED BAGS
Emma Osmond
41 diagrams
8 charts/tables
ISBN: 9781784946180
SKU: GM-50812



CROCHETED TOYS
Emma Osmond
43 diagrams
2 charts/tables
ISBN: 9781784945497
SKU: GM-30353



ENGLISH PAPER PIECING
Janet Goddard
and Jemima Schlee
2 diagrams
25 templates
ISBN: 9781784946432
SKU: GM-51012

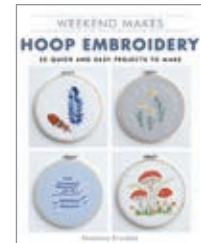

HOOP EMBROIDERY
Rosemary Drysdale
60 illustrations
ISBN: 9781784945909
SKU: GM-50541



MACRAMÉ
Steph Booth
52 diagrams
ISBN: 9781784946197
SKU: GM-50813

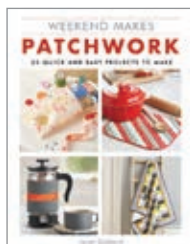

PATCHWORK
Janet Goddard
ISBN: 9781784945114
SKU: GM-29551



PUNCH NEEDLE
Sara Moore
50 illustrations
23 templates
ISBN: 9781784945893
SKU: GM-50540



SIMPLE APPLIQUÉ
Janet Goddard
25 templates
ISBN: 9781784945503
SKU: GM-30352



STASH KNITTING
Emma Osmond
150 illustrations
ISBN: 9781784945121
SKU: GM-29550

FLOWER EMBROIDERY

OVER 100 FLORAL MOTIFS AND PROJECTS TO CREATE

SUSIE JOHNS

From delightful daffodils to cheerful cherry blossoms, this book introduces readers to a range of fundamental embroidery techniques and best practices through easy-to-follow instructions, tips and step-by-steps. Each spread features beautifully photographed projects which vary from pillowcases, table cloths and cutlery wraps, to tea cosies, aprons and picnic cloths. Projects included in this book are suitable for both beginners and more experienced embroiderers. Whether you are a seasoned needlework enthusiast or a budding embroidery artist, this book offers a bouquet of inspiration and step-by-step guidance to create stunning floral masterpieces. Projects include: Lavender Sachets, Buttercups and Daisies Cutlery Wrap, Summer Bouquet Cushion, Honeysuckle Apron, Poppy Picnic Cloth

PB with flaps · 254 × 203 mm · 136 pages
105 Patterns · 102 illustrations · 231 photographs
ISBN: 9781784946814 · SKU: GM-51293 · £16.99

Publishing October 2024

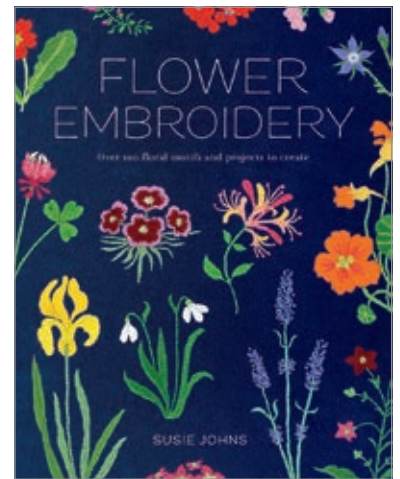

SASHIKO
Jill Clay
PB with flaps
275 × 215 mm · 136 pages
35 templates
110 illustrations
60 photographs
ISBN: 9781784944872
SKU: GM-29247 · £14.99



STITCH
Amy Burt
PB with flaps
254 × 203 mm · 128 pages
20 templates · 300 photographs
ISBN: 9781784945879
SKU: GM-50538 · £12.99



ROSEMARY DRYSDALE is a recognised global expert on blackwork embroidery. She worked as an embroidery designer and has travelled the world teaching workshops and giving demonstrations.



EASY BARGELLO
Rosemary Drysdale
PB with flaps
275 × 215 mm · 144 pages
42 charts · 24 illustrations
86 photographs
ISBN: 9781784946463
SKU: GM-51015 · £16.99



100 MINI CROSS STITCH DESIGNS
Rosemary Drysdale
PB with flaps
275 × 215 mm · 160 pages
100 charts · 150 photographs
ISBN: 9781784946272
SKU: GM-50916 · £16.99

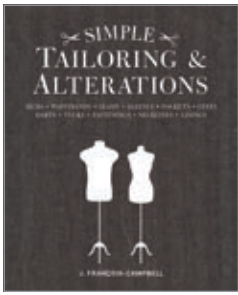

SIMPLE TAILORING & ALTERATIONS

J. François-Campbell

PB with flaps · 254 × 210 mm · 176 pages
426 illustrations · 58 photographs
ISBN: 9781861089595
SKU: GM-22872 · £17.99

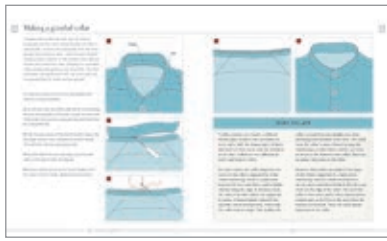

SEW ADORABLE

Vanessa Moonicie

PB with flaps · 235 × 210 mm · 176 pages
3 double-sided pull-out pattern sheets
686 illustrations · 58 photographs
ISBN: 9781861089311
SKU: GM-21509 · £14.99



THE GENTLEMAN'S WARDROBE

Vanessa Moonicie

PB with flaps · 260 × 215 mm · 176 pages
6 pattern sheets
550 illustrations · 70 photographs
ISBN: 9781861087478
SKU: GM-24171 · £22.99

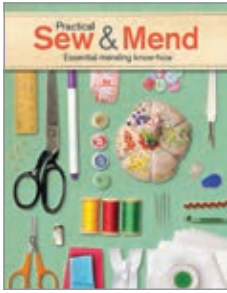

PRACTICAL SEW & MEND

Joan Gordon

PB · 275 × 215 mm · 120 pages
1 illustration · 300 photographs
ISBN: 9781784941765
SKU: GM-26149 · £9.99



SEWN ANIMAL HEADS

Vanessa Moonicie

PB with flaps
254 × 203 mm · 192 pages
15 charts · 567 illustrations
50 photographs
ISBN: 9781784943646
SKU: GM-27669 · £14.99



SEWN BAGS

GMC Editors

PB · 275 × 215 mm · 120 pages
47 templates and 1 chart
24 illustrations · 180 photographs
ISBN: 9781784941710
SKU: GM-26145 · £9.99



DENIM UPCYCLED

Janet Goddard

PB with flaps
275 × 215 mm · 136 pages
30 illustrations · 250 photographs
ISBN: 9781784946449
SKU: GM-51013 · £16.99



HANDMADE LAMPSHADES

Natalia Price-Cabrera

PB with flaps
254 × 203 mm · 192 pages
745 photographs
ISBN: 9781784940690
SKU: GM-25386 · £17.99



MILLINERY

Sarah Lomax & Rachel Skinner

PB with flaps
275 × 215 mm · 152 pages
24 patterns · 5 illustrations
527 photographs
ISBN: 9781784943547
SKU: GM-27550 · £16.99



UPHOLSTERY

David James

PB · 275 × 210 mm · 320 pages
1,450 illustrations · 60 photographs
ISBN: 9781784946555
SKU: GM-51073 · £25.00

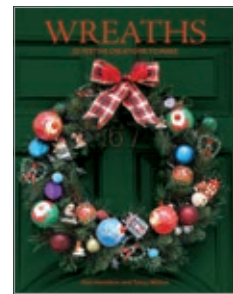

WREATHS

Sian Hamilton and Tansy Wilson

PB · 275 × 215 mm · 96 pages
6 templates · 480 photographs
ISBN: 9781784946593
SKU: GM-51121 · £9.99



DECOUPAGE

GMC Editors

Booklet · 275 × 215 mm · 48 pages
83 photographs
ISBN: 9781784941604
SKU: GM-26134 · £5.99

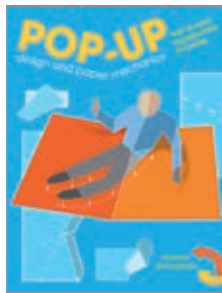

**POP-UP DESIGN
AND PAPER MECHANICS**

Duncan Birmingham

PB · 276 × 210 mm · 176 pages
14 templates · 320 illustrations
200 photographs
ISBN: 9781784945145
SKU: GM-29728 · £16.99



PAPER STARS

Karen-Marie Fabricius

PB · 275 × 215 mm · 144 pages
2 templates · 570 photographs
ISBN: 9781784943370
SKU: GM-27100 · £12.99



PAPER FLOWERS

Jessie Chui

PB · 260 × 210 mm · 256 pages
84 templates · 5 diagrams
505 photographs
ISBN: 9781784946425
SKU: GM-51001 · £19.99

PAULA MILNER is a blogger, tutor, illustrator and fabric designer. She is a brand ambassador for Brother Sewing Machines and a Cricut™ Ambassador.

CRICUT™ CRAFT

PAULA MILNER

Learning how to use a Cricut™ die-cutting machine is made simple and accessible with Cricut™ Craft. This book features 25 projects for household and decorative items, with step-by-step photography and clear text throughout. Each project can be adapted to any Cricut™ machine and contains comprehensive information on the Design Space software, used to create designs and communicate with the machine.

PB · 254 × 203 mm · 144 pages
Full colour throughout
ISBN: 9781784947064 · SKU: GM-51477 · £16.99

Publishing May 2025

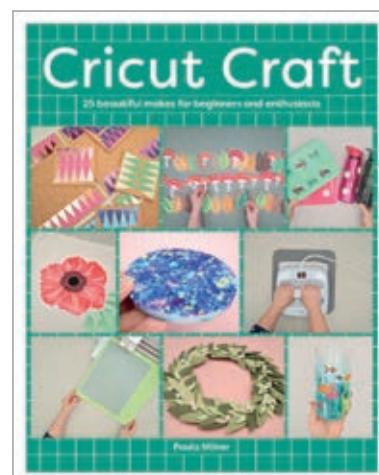

SIMPLE PAPER FLOWERS

25 BEAUTIFUL PROJECTS TO MAKE

PAULA MILNER

From festive holly to delicate primroses and golden marigolds, these paper flowers are astonishing in how realistic they look and how versatile they are – they can be used in bouquets, buttonholes, garlands and in many other ways. Mainly constructed from floristry wire, crepe paper and card, few materials are required. They are perfect for beginners but will also attract experienced crafters who can put their own imprint on the finished make. Projects include: Poppy, Sunflower, Lily, Rose and Dandelion.

PB · 254 × 203 mm · 168 pages
15 templates · 615 photographs
ISBN: 9781784946883 · SKU: GM-51341 · £16.99

Publishing October 2024



SENA RUNA is a professional craftsperson and expert paper quiller. She takes regular commissions, as well as selling her work online. www.senaruna.com

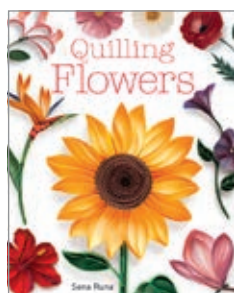

QUILLING FLOWERS

Sena Runa
PB with flaps
254 × 203 mm · 168 pages
20 illustrations · 900 photographs
ISBN: 9781784946562
SKU: GM-51085 · £16.99

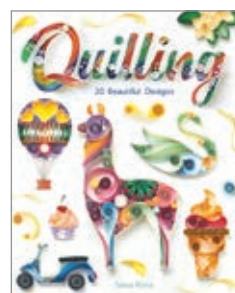

QUILLING

Sena Runa
PB with flaps
254 × 203 mm · 152 pages
20 templates · 760 photographs
ISBN: 9781784945619
SKU: GM-30817 · £14.99



QUILLING ART

Sena Runa
PB with flaps
254 × 203 mm · 136 pages
18 templates · 20 illustrations
514 photographs
ISBN: 9781784943677
SKU: GM-27787 · £14.99



DRAW MANGA
10 STEP-BY-STEP PROJECTS
KEROKO JAMES

Each project in the book covers an element of drawing manga, from faces, body shapes and proportions to different angles and expressions and creating action poses. This bite-size approach allows the reader to build up their skills and confidence before they create more ambitious drawings of their own. The book finishes with composition ideas and how to add backgrounds, giving the reader all the tools they need to create their own manga stories.

PB with flaps · 275 × 215 mm · 128 pages
500 illustrations
ISBN: 9781784946371 · SKU: GM-50954 · £14.99

NEW

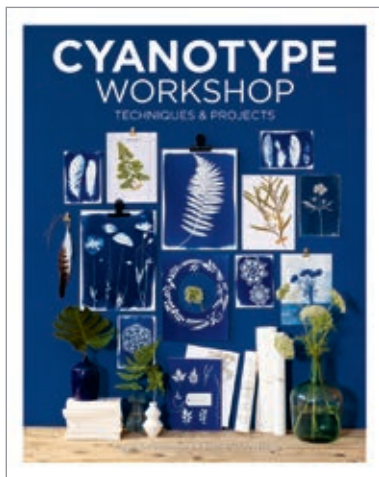

CYANOTYPE WORKSHOP
TECHNIQUES & PROJECTS
CAMILLE SOULAYROL & MARIE VENDITELLI

Cyanotype Workshop is a practical hands-on guide that teaches readers how to make stunning and unique prints using a low-cost and easy camera-less technique.

PB with flaps · 254 × 203 mm · 120 pages
106 photographs
ISBN: 9781784946784 · SKU: GM-51270 · £16.99

NEW

RIGHTS RESTRICTED

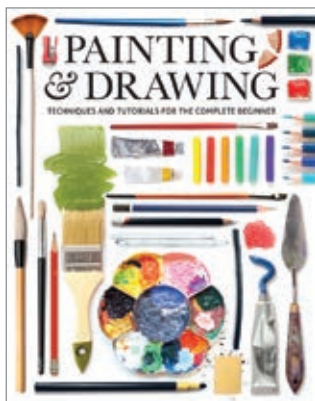

PAINTING & DRAWING
GMC Editors
PB with flaps
275 × 215 mm · 320 pages
700 photographs
ISBN: 9781784945862
SKU: GM-50537 · £19.99

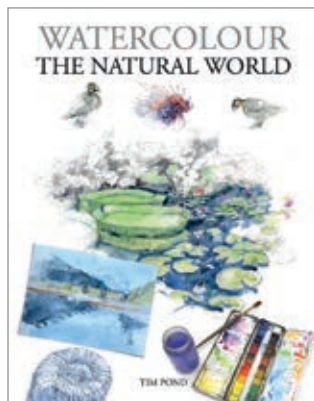

WATERCOLOUR THE NATURAL WORLD
Tim Pond
PB with flaps
275 × 215 mm · 144 pages
500 illustrations · 10 photographs
ISBN: 9781784946395
SKU: GM-50958 · £14.99

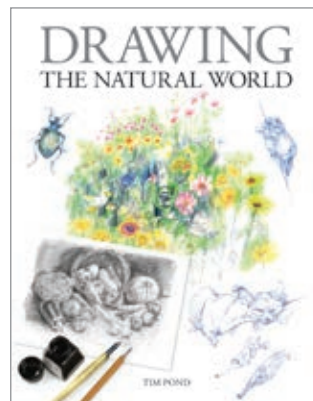

DRAWING THE NATURAL WORLD
Tim Pond
HB · 275 × 215 mm · 144 pages
22 charts/tables · 20 diagrams
403 illustrations · 9 photographs
ISBN: 9781784946388
SKU: GM-50956 · £14.99

TIM POND has attracted worldwide acclaim for his artwork of animals, landscapes and plants. He offers independent animal life drawing classes and is a lecturer on animal movement.
www.timpond.me

ART TECHNIQUES

These step-by-step tutorials are aimed at the complete beginner and cover all of the necessary tools, materials and basic techniques to gain confidence with different art media.

PB with flaps • 275 × 215 mm • 96 pages • Full colour throughout • £9.99

LANDSCAPES IN WATERCOLOUR

TECHNIQUES AND TUTORIALS FOR THE COMPLETE BEGINNER

LOIS DAVIDSON

Landscapes in Watercolour comprises ten tutorials for the absolute beginner to achieve stunning results. The diverse selection of landscapes range from a midwinter farm and a sunny woodland to a coastal waterfront and boats in an estuary. Each watercolour is broken down into four or five stages, showing how to build up a painting from the background colour and add the finishing details. Interspersed with the tutorials are special masterclasses covering trees, skies and reflections. There is also a section on choosing tools and materials, and introductory topics on colour theory, composition and perspective, and the essential basic drawing and painting techniques.

190 photographs

ISBN: 9781784946838 • SKU: GM-51301

NEW



ACRYLICS

Adrian Burrows

10 illustrations • 182 photographs

ISBN: 9781784944063

SKU: GM-28405

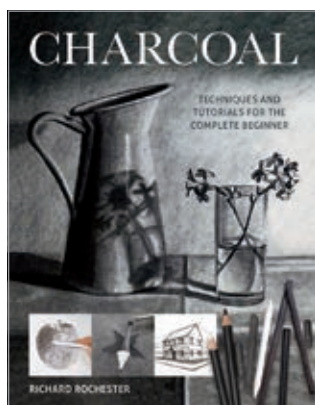

CHARCOAL

Richard Rochester

167 photographs

ISBN: 9781784945527

SKU: GM-30412

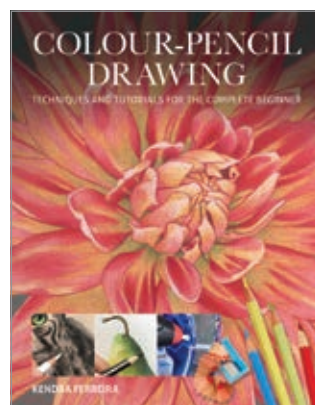

COLOUR-PENCIL DRAWING

Kendra Ferreira

20 illustrations • 180 photographs

ISBN: 9781784945305

SKU: GM-29852

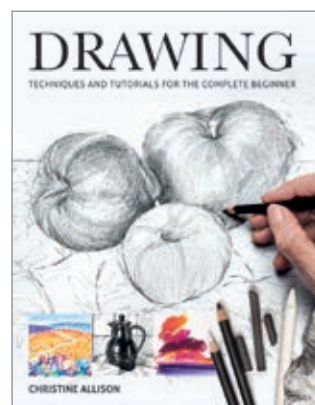

DRAWING

Christine Allison

9 illustrations • 161 photographs

ISBN: 9781784943882

SKU: GM-27991

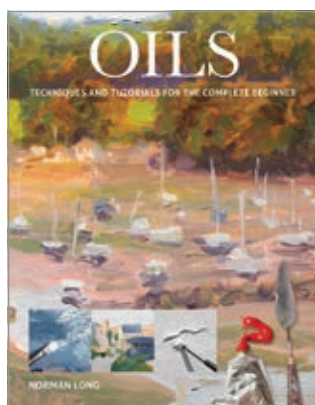

OILS

Norman Long

190 photographs

ISBN: 9781784944056

SKU: GM-28406

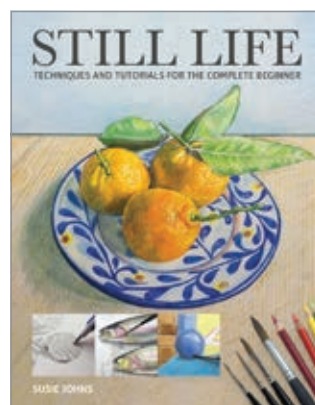

STILL LIFE

Susie Johns

190 photographs

ISBN: 9781784946173

SKU: GM-50811



WATERCOLOUR

Paul Clark

193 photographs

ISBN: 9781784943738

SKU: GM-27874

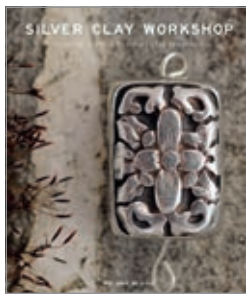

SILVER CLAY WORKSHOP

Melanie Blaikie

PB with flaps · 254 × 203 mm · 160 pages
1 illustration · 436 photographs
ISBN: 9781784944803
SKU: GM-29039 · £16.99



THE BIG BOOK OF JEWELRY MAKING

PB · 219 × 219 mm · 360 pages
50 illustrations · 380 photographs
ISBN: 9781784941185
SKU: GM-25763 · £14.99

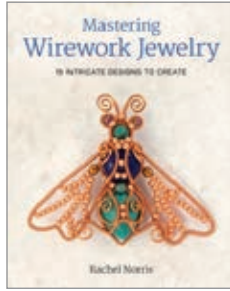

MASTERING WIREWORK JEWELRY

Rachel Norris
PB · 254 × 203 mm · 304 pages
16 templates · 1,700 photographs
ISBN: 9781784943318
SKU: GM-26907 · £19.99



WIRE JEWELRY

Kath Orsman
Booklet · 275 × 215 mm · 48 pages
210 photographs
ISBN: 9781784941666
SKU: GM-26140 · £5.99



MINI MENAGERIE

Lynn Allingham
PB with flaps · 275 × 215 mm
192 pages
740 photographs
ISBN: 9781784944599
SKU: GM-28827 · £16.99



MAKING MINIATURE FOOD & MARKET STALLS

Angie Scarr
PB · 276 × 210 mm · 144 pages
10 illustrations · 400 photographs
ISBN: 9781784944445
SKU: GM-28813 · £16.99

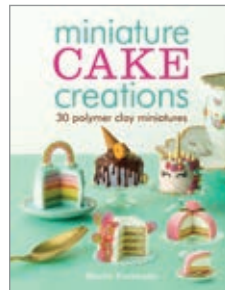

MINIATURE CAKE CREATIONS

Maive Ferrando
PB with flaps · 275 × 215 mm
208 pages
1 chart · 550 photographs
ISBN: 9781784945374
SKU: GM-29959 · £16.99



THE WORLD OF MINIATURES

Sarah Walkley
HB with jacket · 260 × 230 mm
192 pages
7 illustrations · 500 photographs
ISBN: 9781784944025
SKU: GM-28383 · £25.00

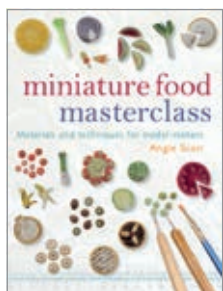

MINIATURE FOOD MASTERCLASS

Angie Scarr
PB · 248 × 186 mm · 160 pages
1 chart/table · 56 scale diagrams
477 photographs
ISBN: 9781861085252
SKU: GM-16388 · £16.99



MAKING MINI FOOD

Lynn Allingham
PB with flaps · 275 × 215 mm
208 pages
12 charts · 688 photographs
ISBN: 9781784943660
SKU: GM-27674 · £19.99



COLOURING

Relax into the creative world of colouring. Containing beautiful and diverse collections of illustrations with fantasy and mythical themes, these books will appeal to both adults and children.

PB • 275 × 210 mm • 128 pages
b/w illustrations throughout



FANTASY COLOURING

64 illustrations
ISBN: 9781784945329 • SKU: GM-29973 • £6.99

MYTHICAL COLOURING

64 illustrations
ISBN: 9781784946821 • SKU: GM-51298 • £7.99

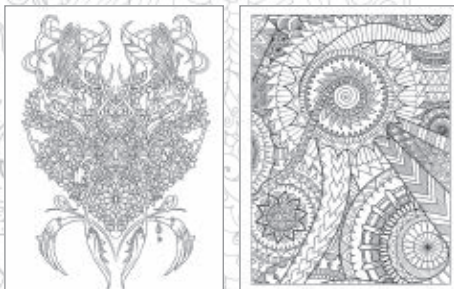

ZENTANGLE® ART THERAPY

Anya Lothrop, CZT
Booklet • 297 × 210 mm • 64 pages
250 illustrations • b/w throughout
ISBN: 9781784941079
SKU: GM-25681 • £5.99

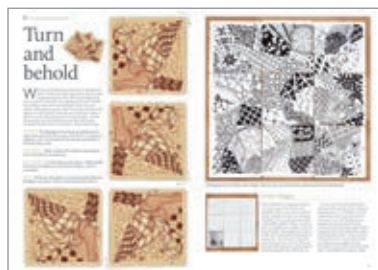
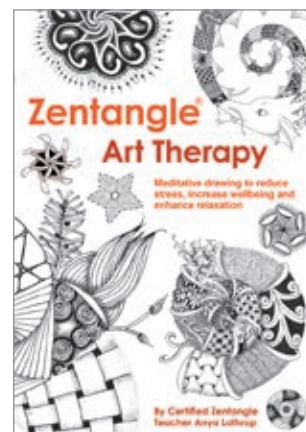

THE BIG BOOK OF 100 LITTLE ACTIVITIES
Laura Minter & Tia Williams
PB with flaps
254 × 203 mm • 144 pages
Full colour throughout
ISBN: 9781784942458
SKU: GM-26500 • £14.99

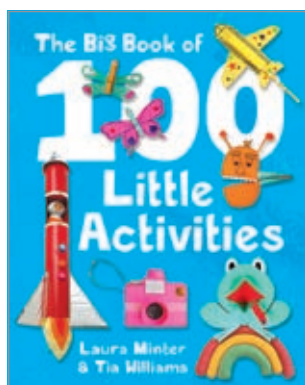

THE BIG BOOK OF 100 OUTDOOR ACTIVITIES
Laura Minter & Tia Williams
PB with flaps
254 × 203 mm • 144 pages
Full colour throughout
ISBN: 9781784944049
SKU: GM-28407 • £14.99

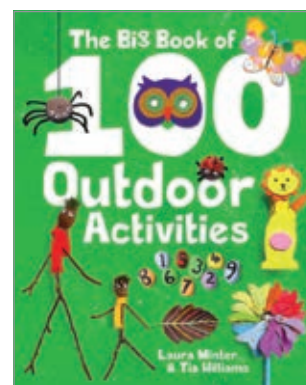

ECO CRAFT BOOK
Laura Minter & Tia Williams
PB with flaps
275 × 215 mm • 144 pages
Full colour throughout
ISBN: 9781784945695
SKU: GM-30868 • £12.99



CHRISTMAS CRAFT BOOK
Laura Minter & Tia Williams
PB with flaps
275 × 215 mm • 144 pages
Full colour throughout
ISBN: 9781784946234
SKU: GM-50817 • £12.99



THE MERMAID CRAFT BOOK
Laura Minter & Tia Williams
Booklet
275 × 215 mm • 64 pages
Full colour throughout
ISBN: 9781784945107
SKU: GM-29536 • £5.99



KIDS KNIT
Kerry Kimber
PB with flaps
275 × 215 mm • 128 pages
Full colour throughout
ISBN: 9781784945824
SKU: GM-50455 • £12.99



THE ART OF CHAIRMAKING

JASON MOSSERI

'Windsor' chairs, where the legs are mortised into the seat and don't form the backrest, are known for the striking elegance of their form. This book is the perfect introduction to the art of making these distinctive chairs, with essential information on tools, materials, and techniques. The book includes 5 projects: 3-legged round stool, square table, simple bench, course armchair and comb back armchair.

HB · 253 × 195 mm · 160 pages

Full colour throughout

ISBN: 9781784947019 · SKU: GM-51432 · £25.00

Publishing May 2025

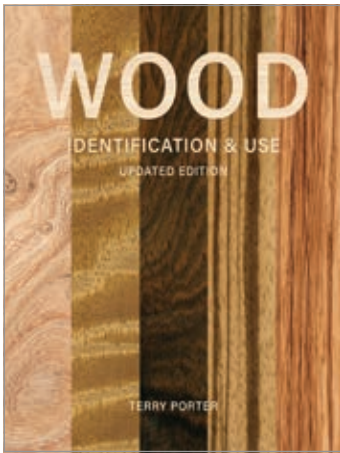

WOOD IDENTIFICATION & USE

UPDATED EDITION

TERRY PORTER

The indispensable guide to the world's most valuable natural resource. This updated edition of the bestselling book includes photographs and key information for more than 200 species of wood, with up-to-date information on wood availability. The book details working properties, seasoning requirements, uses and safety considerations as well as sections on decorative figuring, wood defects and potential health hazards. Aimed at small-scale users, whether professional or amateur, it includes woods used in cabinetmaking, joinery, carpentry, turning, carving and a host of more specialist applications.

HB · 254 × 203 mm · 288 pages

Full colour throughout

ISBN: 9781784947101 · SKU: GM-51493 · £24.99

Publishing May 2025



WOOD ID HANDBOOK

Terry Porter

HB · 210 × 148 mm

144 pages

300 illustrations

150 photographs

ISBN: 9781784946227

SKU: GM-50816 · £14.99



WOODEN JEWELLERY BOXES

GMC EDITORS

Featuring 20 projects from talented box-makers, *Wooden Jewellery Boxes* teaches readers essential box-making techniques. From small ring boxes and trinket containers to larger boxes with several drawers, the projects in this book showcase a variety of construction and decorative techniques, such as dovetails, inlay, veneering and using contrasting timbers. The boxes included can be made to mark special occasions or to store sentimental items and keepsakes and advice is given on how to personalise the projects.

PB · 276 × 210 mm · 144 pages

Full colour throughout

ISBN: 9781784947118 · SKU: GM-51494 · £16.99

Publishing June 2025

JAPANESE JOINERY

DORIAN BRACHT

Japanese Joinery showcases traditional and modern joinery techniques through beautiful photography and detailed technical illustrations. The joints are illustrated by photographs of them both complete and deconstructed, and there are also hand-drawn technical illustrations. The accompanying text describes the history of each joint, how they are used, variations, and tips on how the joints are constructed. There is also a comprehensive section on Japanese woodworking tools.

HB cloth · 276 × 210 mm · 176 pages

10 templates · 250 photographs

ISBN: 9781784945565 · SKU: GM-30483 · £35.00

NEW

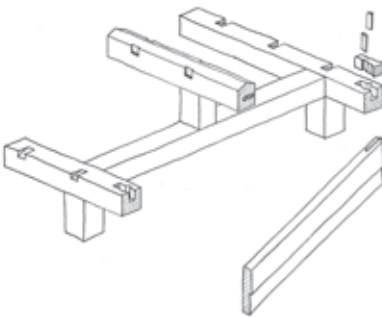
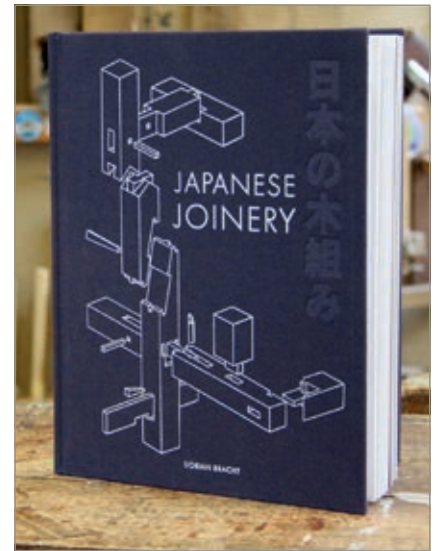

WOOD JOINTS BY MACHINE & BY HAND

RANDALL A. MAXEY

An indispensable joinery reference book, *Wood Joints By Machine & By Hand* provides the perfect introduction for novices and an ideal companion for more accomplished woodworkers looking to brush up on their skills. Includes: Butt Joint, Miter Joint, Dowel Joint, Mortise and Tenon Joint, Box Joint and Through Dovetail Joint.

PB with flaps · 276 × 210 mm · 176 pages

37 illustrations/diagrams · 673 photographs

ISBN: 9781784946579 · SKU: GM-51086 · £16.99

Publishing September 2024

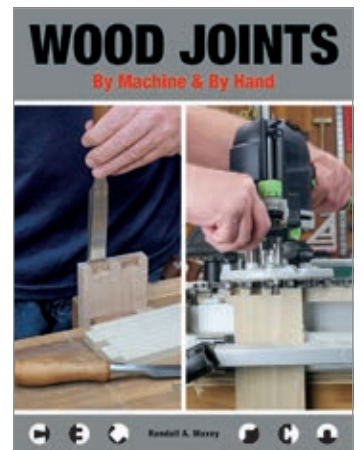

OAK-FRAMED BUILDINGS

NEW EDITION

RUPERT NEWMAN

This is a practical book on the technique of timber-frame construction for carpenters, builders and aspiring self-builders, but it will also be a source of inspiration to anyone who appreciates beautiful buildings. Full-colour photographs show projects by the author and others both complete and under construction, and structural details are clearly explained both in photographs and in three-dimensional drawings. Here is a traditional craft brought fully up to date for the 21st century.

PB with flaps · 260 × 215 mm · 192 pages

90 illustrations · 185 photographs

ISBN: 9781784946616 · SKU: GM-51142 · £24.99

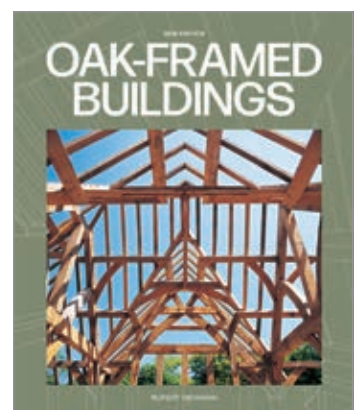

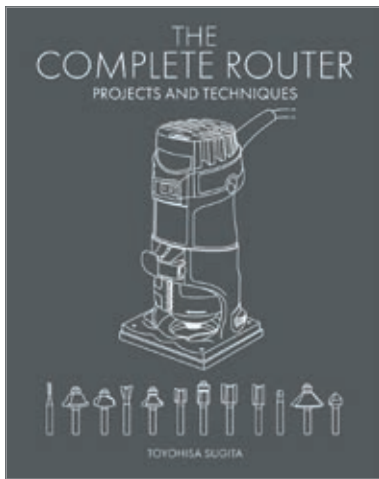

NOT FINAL COVER

THE COMPLETE ROUTER

PROJECTS AND TECHNIQUES

TOYOHISA SUGITA

The comprehensive guide to using router trimmers and tables, including 16 projects suitable for all skill levels. The book is full of tutorials and tips that enable anyone to get to grips with fundamental routing techniques such as cutting and joining. Projects include a desktop storage box, a photo frame and kitchen chopping board.

PB with flaps · 254 × 203 mm · 256 pages

Full colour throughout

ISBN: 9781784946982 · SKU: GM-51417 · £25.00

Publishing May 2025

RIGHTS RESTRICTED



WOODWORKING JOINERY BY HAND

INNOVATIVE TECHNIQUES USING JAPANESE SAWS AND JIGS

TOYOHISA SUGITA

Woodworking Joinery by Hand is a ground-breaking woodworking book that introduces a new twist on the traditional hand-cut methods of joint making. With Sugita's unique method of guiding and controlling the saw blade using jigs and magnetic sheets, even a complete beginner can learn advanced joint-making techniques with hand tools alone. Making it easy to produce straight and square cuts, this pioneering technique is a game-changer for producing high-precision, beautifully made wooden joints.

PB with flaps · 254 × 203 mm · 280 pages

150 illustrations · 950 photographs

ISBN: 9781784946524 · SKU: GM-51053 · £25.00

RIGHTS RESTRICTED



SIMPLE JAPANESE FURNITURE

24 MID-CENTURY PROJECTS FOR YOUR HOME

COMPILED BY GROUP MONOMO

Simple Japanese Furniture presents 24 simple and stylish furniture projects for the home based on timeless Japanese designs from the mid-1950s. Each project presents notes on the key design elements, the tools and techniques needed, and step-by-step instructions. The projects are described in a brief overview, with notes on degree of difficulty and an emphasis on key design elements. Appealing to woodworkers and hand-tool enthusiasts, the book reflects growing interest in making simple practical furniture for the home as well as an appreciation of Japanese design.

PB with flaps · 254 × 203 mm · 184 pages

214 diagrams · 580 photographs

ISBN: 9781784946326 · SKU: GM-50921 · £16.99

RIGHTS RESTRICTED

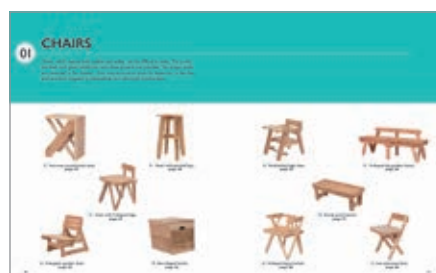

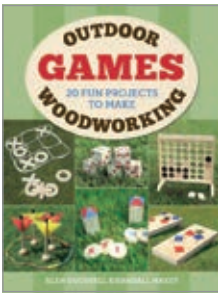

OUTDOOR WOODWORKING GAMES
 Alan Goodsell & Randall Maxey
 PB · 276 × 210 mm · 128 pages
 53 illustrations · 322 photographs
 ISBN: 9781784943745
 SKU: GM-27873 · £14.99



SUPER SIMPLE OUTDOOR WOODWORKING
 Randall A. Maxey
 PB with flaps
 276 × 210 mm · 128 pages
 75 diagrams · 350 photographs
 ISBN: 9781784946203
 SKU: GM-50814 · £14.99

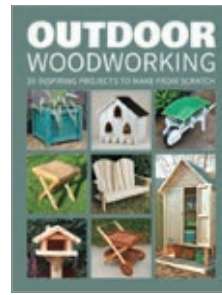

OUTDOOR WOODWORKING
 GMC Editors
 PB · 276 × 210 mm · 136 pages
 60 illustrations · 550 photographs
 ISBN: 9781784942472
 SKU: GM-26502 · £14.99



BIRD HOUSE MAKE AND MAKEOVER
 Alan Goodsell
 PB · 276 × 210 mm · 160 pages
 14 illustrations · 550 photographs
 ISBN: 9781784945190
 SKU: GM-29825 · £14.99



PALLET CRAFT
 Emma Basden
 PB with flaps
 276 × 210 mm · 144 pages
 312 photographs
 ISBN: 9781784944865
 SKU: GM-29244 · £14.99



ONE-PLANK WOODWORKING PROJECTS
 Andy Standing
 PB · 276 × 210 mm · 176 pages
 21 illustrations · 595 photographs
 ISBN: 9781861088987
 SKU: GM-19396 · £16.99



WOODWORKING FROM OFFCUTS
 Derek Jones
 PB · 276 × 210 mm · 176 pages
 30 illustrations · 380 photographs
 ISBN: 9781861088833
 SKU: GM-19393 · £16.99



WOODWORKING BASICS
 Alan Goodsell & Randall Maxey
 PB with flaps
 276 × 210 mm · 160 pages
 56 illustrations · 394 photographs
 ISBN: 9781784944087
 SKU: GM-28403 · £14.99



WEEKEND WOODWORKING
 GMC Editors
 PB · 276 × 210 mm · 176 pages
 80 illustrations · 576 photographs
 ISBN: 9781784942434
 SKU: GM-26498 · £14.99



BOX MAKING
 GMC Editors
 PB · 276 × 210 mm · 160 pages
 95 illustrations · 550 photographs
 ISBN: 9781784942465
 SKU: GM-26501 · £14.99



MAKING HEIRLOOM BOXES
 Peter Lloyd
 PB with flaps
 276 × 210 mm · 176 pages
 83 line drawings · 122 colour drawings
 212 photographs
 ISBN: 9781861081766
 SKU: GM-HEIRLOOM-0 · £16.99



THE COMPLETE GUIDE TO JOINT-MAKING
 John Bullar
 PB · 276 × 210 mm · 176 pages
 34 illustrations · 600 photographs
 ISBN: 9781861088789
 SKU: GM-19392 · £16.99



MARK BAKER was the Group Editor of GMC's portfolio of woodworking magazines and a globally well-known woodturning demonstrator.



WOODTURNING PROJECTS

152 illustrations
447 photographs
ISBN: 9781861083913
SKU: GM-WOOD-2

PB · 276 × 210 mm
192 pages
Full colour throughout
£16.99

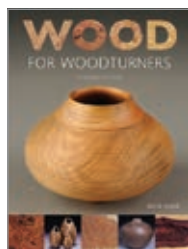

WOOD FOR WOODTURNERS

Revised Edition
1 chart
8 illustrations/diagrams
344 photographs
ISBN: 9781784941260
SKU: GM-25773



WEEKEND WOODTURNING PROJECTS

2 charts
25 illustrations
619 photographs
ISBN: 9781861089229
SKU: GM-22214

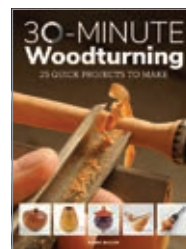

30-MINUTE WOODTURNING

200 pages
127 illustrations
514 photographs
ISBN: 9781784943981
SKU: GM-28086

DAVID SPRINGETT has been a professional woodturner for over 30 years and has demonstrated his experimental techniques around the world.

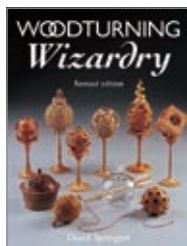

WOODTURNING WIZARDRY

101 illustrations · 374 photographs
ISBN: 9781861084224
SKU: GM-WOOD-6

PB · 276 × 210 mm
192 pages
Full colour throughout
£16.99



WOODTURNING FULL CIRCLE

82 diagrams · 500 photographs
ISBN: 9781861085313
SKU: GM-17038



WOODTURNING TRICKERY

160 pages
60 illustrations · 340 photographs
ISBN: 9781861087386
SKU: GM-24279



TURNING HOLLOW FORMS

Mark Sanger
PB · 276 × 210 mm · 168 pages
35 illustrations
338 photographs
ISBN: 9781861088932
SKU: GM-19395 · £16.99



PEN TURNING: A FOUNDATION COURSE

Kip Christensen & Rex Burningham
PB · 276 × 210 mm · 120 pages
220 photographs
ISBN: 9781784943684
SKU: GM-27788 · £14.99



WOODTURNING DESIGN

Derek Hayes
PB · 276 × 210 mm · 176 pages
177 illustrations
323 photographs
ISBN: 9781861088659
SKU: GM-18459 · £19.99

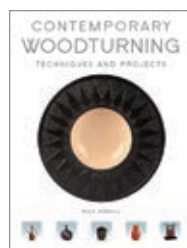

CONTEMPORARY WOODTURNING

Nick Arnall
PB · 276 × 210 mm · 192 pages
48 illustrations
753 photographs
ISBN: 9781861088734
SKU: GM-19391 · £19.99



TURNING VINTAGE TOYS

Chris Reid
PB · 276 × 210 mm · 176 pages
50 illustrations
390 photographs
ISBN: 9781861086020
SKU: GM-17618 · £16.99

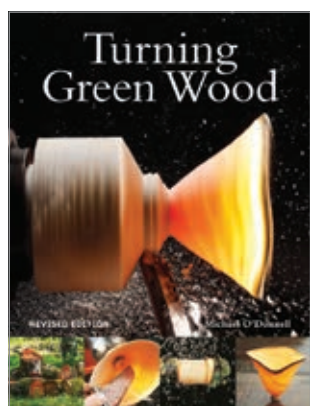

TURNING GREEN WOOD

REVISED EDITION
MICHAEL O'DONNELL

Using green (unseasoned) timber allows you to choose and cut your own wood. In this inspiring and thought-provoking guide, Michael O'Donnell, one of the foremost exponents of the technique, explains how to harvest and store timber and how to make the best use of the grain pattern and other properties. With clear text and spectacular photographs to show exactly how this is done, this book demystifies one of the most admired techniques used by woodturners today. It also features six inspirational projects to make.

PB · 276 × 210 mm · 144 pages
90 illustrations · 250 photographs
ISBN: 9781784945589
SKU: GM-30655 · £16.99

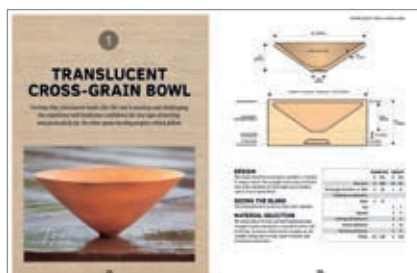

RICHARD FINDLEY specialises in bespoke hand turning. He is an established demonstrator, magazine contributor and a member of the Register of Professional Turners. www.turnersworkshop.co.uk

CREATIVE WOODTURNING PROJECTS

RICHARD FINDLEY

Creative Woodturning Projects presents 16 inspiring woodturning projects incorporating innovative techniques and created by one of the UK's leading turners.

PB · 276 × 210 mm · 160 pages
5 illustrations · 525 photographs
ISBN: 9781784946869 · SKU: GM-51319 · £16.99

NEW

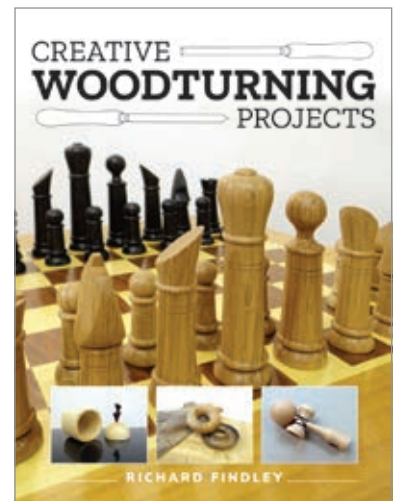

TURNING DECORATIVE BOWLS

RICHARD FINDLEY

Turning Decorative Bowls presents innovative decorative techniques, materials and projects.

PB · 276 × 210 mm · 156 pages
6 illustrations · 468 photographs
ISBN: 9781784946739 · SKU: GM-51214 · £16.99

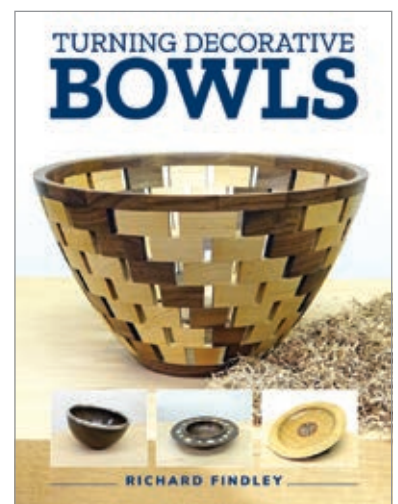

WOODTURNING: A FOUNDATION COURSE

NEW EDITION

KEITH ROWLEY, UPDATED BY ANDY COATES

Keith Rowley's best-selling introduction to the art of woodturning is exceptional for its friendly and methodical approach, building up the reader's skills and confidence through logical and progressive steps.

PB · 276 × 210 mm · 192 pages
300 illustrations · 350 photographs
ISBN: 9781784945671 · SKU: GM-30866 · £16.99

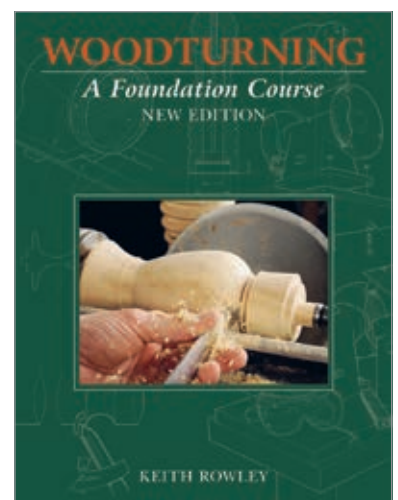

A WOODWORKER'S GUIDE

A *Woodworker's Guide* is ideal for woodworkers of all abilities. The contents provide an in-depth explanation of equipment, essential techniques and include a range of projects.



SHARPENING
Randall A. Maxey
144 pages
290 photographs
ISBN: 9781784944407
SKU: GM-28809

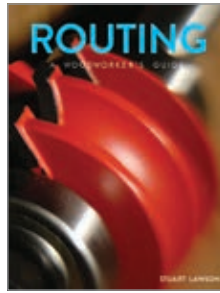

ROUTING
Stuart Lawson
13 illustrations
275 photographs
ISBN: 9781784944421
SKU: GM-28811



SCROLLSAWS
Fred and Julie Byrne
1 chart/table · 11 diagrams
33 templates
301 photographs
ISBN: 9781784944438
SKU: GM-28810



JOINTS
Ralph Laughton
339 photographs
ISBN: 9781784944414
SKU: GM-28812

PB · 276 × 210 mm
176 pages
Full colour throughout
£16.99

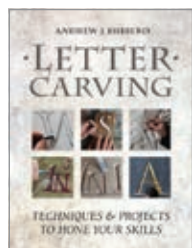

LETTER CARVING
Andrew Hibberd
PB · 276 × 210 mm · 192 pages
30 illustrations · 535 photographs
ISBN: 9781861089526
SKU: GM-22391 · **£16.99**



THE ART OF CHIP CARVING
Tatiana Baldina
PB · 276 × 210 mm · 176 pages
15 illustrations · 684 photographs
ISBN: 9781784946623
SKU: GM-51150 · **£16.99**



CHIP CARVING
Tatiana Baldina
PB · 276 × 210 mm · 176 pages
15 templates · 700 photographs
ISBN: 9781784945466
SKU: GM-30192
£14.99



CARVING JAPANESE NETSUKE FOR BEGINNERS
Robert Jubb
PB · 248 × 186 mm · 176 pages
106 illustrations · 740 photographs
ISBN: 9781861086938
SKU: GM-18197 · **£16.99**



STICKMAKING: A COMPLETE COURSE
Andrew Jones & Clive George
PB · 276 × 210 mm · 176 pages
81 b/w drawings · 237 photographs
ISBN: 9781861085221
SKU: GM-15698 · **£19.99**



STICKMAKING HANDBOOK
Andrew Jones & Clive George
PB · 210 × 148 mm · 120 pages
81 illustrations · 237 photographs
ISBN: 9781784940980
SKU: GM-25610 · **£9.99**

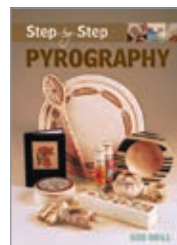

STEP-BY-STEP PYROGRAPHY
Bob Neill
PB · 297 × 210 mm · 80 pages
200 photographs
ISBN: 9781861084910
SKU: GM-PYRO-1 · **£9.99**



SOLID-POINT PYROGRAPHY
Lisa Shackleton
PB · 276 × 210 mm · 80 pages
52 templates · 142 photographs
ISBN: 9781784945206
SKU: GM-29830 · **£9.99**

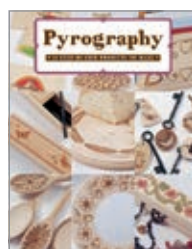

PYROGRAPHY
Bob Neill
Booklet · 275 × 215 mm · 48 pages
17 illustrations · 175 photographs
ISBN: 9781784941611
SKU: GM-26136 · **£5.99**

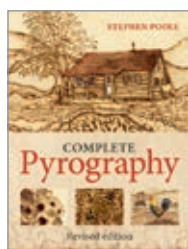

COMPLETE PYROGRAPHY
Stephen Poole
PB · 276 × 210 mm · 160 pages
95 illustrations · 120 photographs
ISBN: 9781861087102
SKU: GM-23314 · **£16.99**

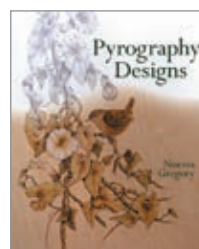

PYROGRAPHY DESIGNS
Norma Gregory
PB · 276 × 210 mm · 128 pages
358 illustrations · 27 photographs
ISBN: 9781861081162
SKU: GM-PYROGRAPHY-1 · **£12.99**



GMC PUBLICATIONS LTD
166 HIGH STREET, LEWES BN7 1XU

PUBLISHER

JONATHAN BAILEY

Email: jonathanb@thegmcgroup.com

RIGHTS & MARKETING

MELANIE ARORA

Email: mela@thegmcgroup.com

SALES

MICHAEL ROBB

Tel: 07900 2182200

Email: michaelr@thegmcgroup.com

PUBLICITY

PAUL ECKERSLEY

Tel: 01273 402836

Email: paul.eckersley@thegmcgroup.com

ORDERING INFORMATION

UNITED KINGDOM

GMC DISTRIBUTION GENERAL RETAIL

Tel: 01273 488005

Email: orders@thegmcgroup.com

JOHN WILEY & SONS BOOK TRADE

Tel: 01243 843291

Email: Gmc.csd@wiley.com

www.gmcdistribution.com

NORTH AMERICA

INGRAM CONTENT GROUP, LLC

Tel: 800.937.8200

Email: ips@ingramcontent.com

www.ingramcontent.com

AUSTRALIA

PERIBO PTY LTD

Tel: 0294570011

Email: info@peribo.com.au

www.peribo.com.au

NEW ZEALAND

BATEMAN BOOKS

Tel: (64 9) 415 7664 extn. 0

Email: info@batemanbooks.co.nz

www.batemanbooks.co.nz

For all other enquiries, please contact Michael Robb

www.gmcbooks.com

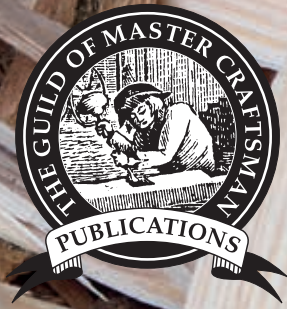

www.gmcbooks.com